



User's Manual

DU6771

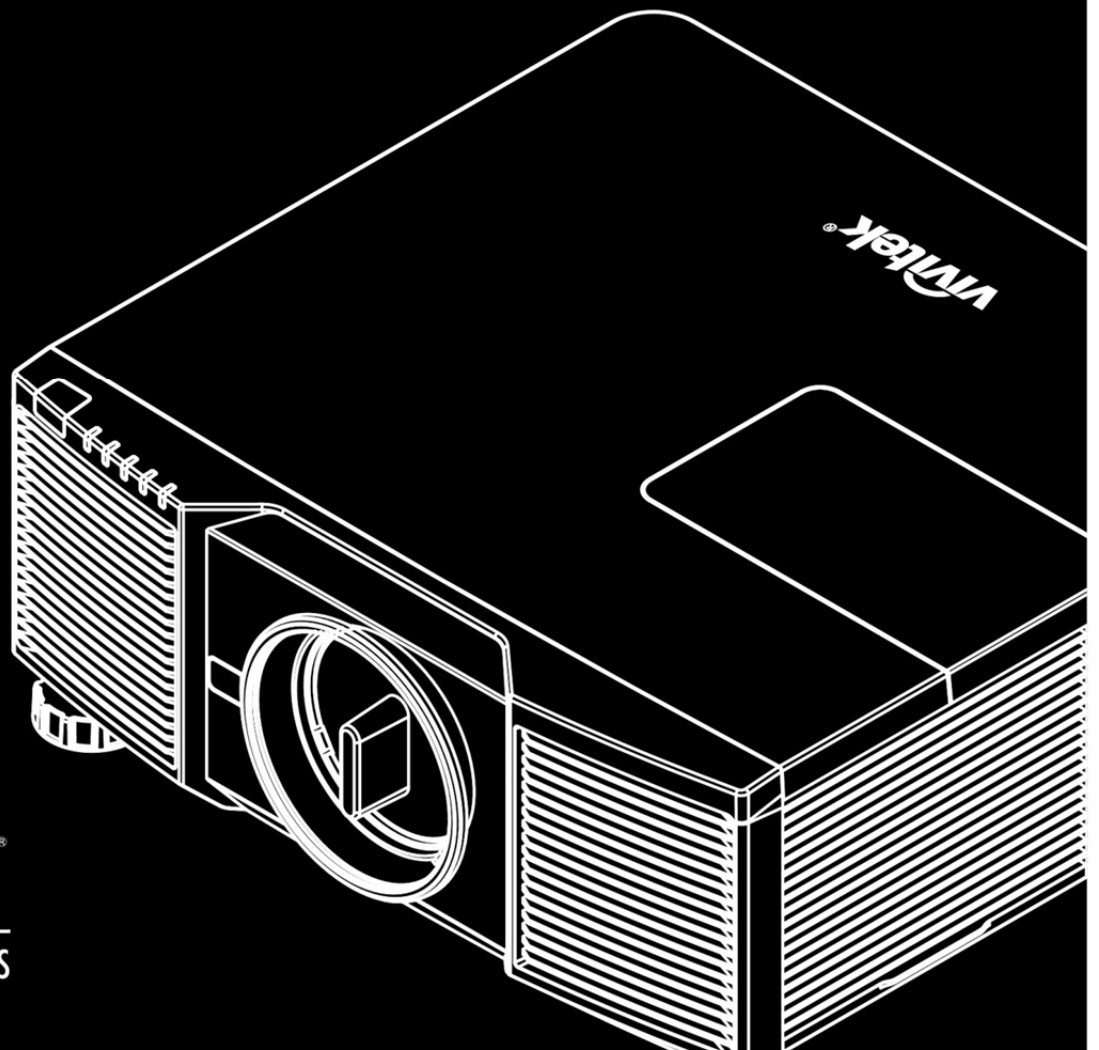

Table of Contents

Copyright 2

 Copyright..... 2

 Disclaimer 2

 About the Manual..... 2

Important Safety Guidelines 3

 Safety Notification 3

 Installation and Use Notices 4

 Disposal of Old Electric and Electronic Equipment 4

 Important Recycling Instructions..... 4

Introduction..... 5

 Packing Checklist..... 5

 Projector Overview..... 6

 IO Panel 8

 Control Panel 9

 Remote Control 10

Installation and Setting up the Projector 12

 Inserting or Replacing the Remote Control Batteries 12

 Installing the Projector 13

 Installing or Removing the Optional Lens 15

 Turning on the Projector 17

 Turning off the Projector..... 18

 Setting up the Cooling Condition 19

 Setting up the Projection Mode..... 19

 Adjusting Projected Image Position 20

 Adjusting the Focus and Zoom 20

 Correcting Keystone Distortion 21

 Correcting Distortion at the Corner 22

 Using Control ID for Multi-projector Application 23

 Preventing the Unauthorized Use of the Projector 25

 Using the Control Panel Lock 25

 Using Security Lock 25

 Using the Screw to Lock the Projection Lens 26

Making Connections..... 27

 Connecting to Personal Computer..... 27

 Connecting to the Video Device..... 27

 Connecting to the Control Equipment..... 28

 Connecting to the Screen Trigger 29

 Connecting to External HDBaseT Transmitter 30

Using the projector 31

 Using On-Screen Display..... 31

 Menu Tree..... 32

 OSD Operation - PICTURE 36

 OSD Operation - SIGNAL..... 38

 OSD Operation - SETUP 39

 OSD Operation - INSTALLATION..... 43

 OSD Operation - SERVICE 49

Product Specification 50

Supported Signal Input Timing 51

Configurations of Terminals..... 53

DU6771 Lens Series 54

Product Dimensions 55

Replacing the Projection Lamps 56

Replacing the Filter 58

Cleaning the Projector..... 59

Troubleshooting..... 60

 LED Indication..... 60

 Tips for Troubleshooting 61

About the Vivitek Support..... 63

Copyright

Copyright

The User's Manual (including all pictures, illustrations and software) is protected by the international copyright right law. All rights are reserved. No duplication of the manual or any content included in the manual is allowed without the written consent of the manufacturer.

Vivitek is the trademark of Vivitek Corporation. ©All rights reserved. 2016

Disclaimer

The information in the manual is subject to change without notice. The manufacturer does not provide any statement or warranty of the contents in the manual and clearly give up the implied warranties of merchantability and of fitness for a particular purpose. The manufacturer reserves the rights to modify the publication and change the contents of the materials at any time without notice to any person.

About the Manual

The manual describes how to install and use the projector and is applicable to the end-user. Relevant information (such as illustrations and descriptions) is put on the same page as possible as we can. The format, easy for printing, is convenient for reading and paper-saving which is beneficial to environmental protection. It is suggested printing the page you need.

Important Safety Guidelines

Thank you for purchasing the high quality product!

Read the Manual carefully to obtain the best performance. The Manual provides instructions to use the menu and implement operation.

Safety Notification

CAUTION

To turn off main power, ensure to unplug from power outlet.



CAUTION

To prevent the projector from electrical discharge or electric shock, do not expose the projector to rain or moist environment. Do not use the plug with an extension cord or an outlet unless all the prongs can be fully inserted.



CAUTION

To prevent electric shock, do not open the cabinet. There are high-voltage components inside. Refer service to qualified service personnel.



This symbol alerts the user that important information which should be read carefully to avoid problems concerning the operation and maintenance.

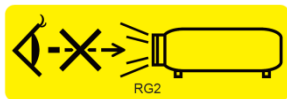

As with any bright light source, do not stare into the beam, RG2 IEC 62471-5:2015

WARNING TO CALIFORNIA RESIDENTS:

Handling the cables supplied with this equipment might expose user to a little lead, a chemical known to the State of California, resulting in risks of barrenness. Please remember to wash hands after handling.

NOTIFICATION (CANADA)

This class B digital equipment complies with Canadian ICES-003.

CE NOTIFICATION

This is a class B product, which complies with rules for CE marking. This product may cause radio interference that the user may be supposed to take adequate measures.

FCC NOTIFICATION

This device complies with the limits for a Class B digital device, pursuant to Part 15 of the FCC Rules. These limits are designed to provide reasonable protection against harmful interference in a residential installation. This device generates, uses and can radiate radio frequency energy, it may cause harmful interference to radio communications if not installed and used in accordance with the installation instructions,

FCC CAUTION: To assure product compliance as testing, follow the installation instructions and use only shielded cables when connecting to the peripheral devices. Any changes or modifications not expressly recognized by Vivitek could void the user's authority to operate this device.

Notification to Korea

This equipment is home use (Class B) electromagnetic wave suitability equipment and to be used mainly at home and it can be used in all areas.

B 급 기기 (가정용 방송통신기자재)

이 기기는 가정용(B 급) 전자파적합기기로서 주로 가정에서 사용하는 것을 목적으로 하며, 모든 지역에서 사용할 수 있습니다.

Notification to Norwegian and Swedish

Equipment connected to the protective earthing of the building installation through the mains connection or through other equipment with a connection to protective earthing - and to a cable distribution system using coaxial cable, may in some circumstances create a fire hazard. Connection to a cable distribution system has therefore to be provided through a device providing electrical isolation below a certain frequency range (galvanic isolator, see EN 60728-11).

Installation and Use Notices

1. Read and keep this manual properly.
2. Pay attention to all the noted warnings, and follow all the guidelines and descriptions in this manual.
3. Do not use the projector near water.
4. Do not install the equipment near the thermal sources, such as heaters, radiators, furnace, amplifiers, and any other equipment that may generate heat.
5. Be careful while holding the equipment or moving the trolley with projector to prevent the equipment from turning over.
6. Notice whether there is any parts with flaws after receiving the projector.
7. Please notice that the projector will not power on until the lens is fitted. The protection covering the lens should be taken to install the lens.
8. Do not let any vent be obstructed.
9. Do not destroy the safety protection function of polarized or grounding plug of power cord. A polarized plug has one wide and one narrow blade. The plug has two blades and one grounding blade. The wide blade or grounding blade is provided for the safety concerns. If the plug provided does not match the outlet, please contact the electrician to change outlet.
10. The +12V trigger only outputs 12V DC trigger signal. Do not connect other power input or output. Otherwise, the equipment may malfunction.
11. Adjust the slide switch with suitable volt input, and then plug in the projector; the red LED indicator would flash and then stabilize, getting into standby mode. User should only use the connectors or accessories provided by the manufacturer.
12. When user turns on the projector, the red LED indicator would flash until stabilize. Do not look at the lens directly while the projector is running.
13. Unplug the power cord of the equipment if there is a thunderstorm or the equipment is not going to be used for a long time.
14. The packaging materials can be kept properly for transportation use afterwards.
15. If any breakdown occurs, please contact dealer or manufacture for qualified repair service.

Disposal of Old Electric and Electronic Equipment

The symbol on your product or the package represents that the product should not be treated as the normal household waste when discarded but should be carried to the recycling location of the waste electric and electronic equipment. The consequence on the environment and human health due to the incorrect disposal of the product can be prevented if it can be ensured that the product is properly discarded. Material recycling is helpful to the protection of natural resources. The symbol is only valid in European Union. If you want to discard electrical and electronic equipment, contact the governmental authorities or your dealer for the correct method of disposal.



Important Recycling Instructions

The product may contain other electronic wastes and may pose risk if not discarded properly. Abide by the local, state/provincial or federal laws of recycling or discarding. For more information, please visit the website and contact Electronic Industries Alliance (EIA) on WWW.EIAE.ORG.



Introduction

The User's Manual describes the installation, setup and operation of the projector and provides assistance to the installation personnel and the end-user to fully develop the performance of the projector. Vivitek has made every effort to ensure that the information in the Manual is correct at the time of printing. The contents may be frequently updated due to the continuously product improvement and customer feedback. You can find the latest version of the Manual and the manual of other Vivitek products on www.vivitekcorp.com.

Packing Checklist

The following items are included in the packaging box of the projector. If any loss or damage to any item, contact your dealer or Vivitek customer service department.

AC Power Cord



Power Cord



VGA Signal Cable

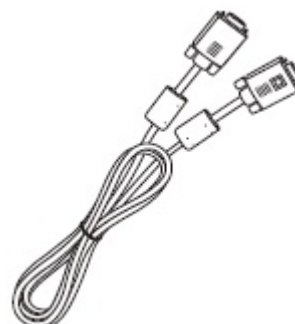

IR Remote Control



Wired Remote Cable



Anti-theft Screw (M4)
(for Lens Installation)

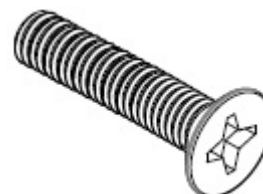

User's Manual Disc



RoHS Card (China)

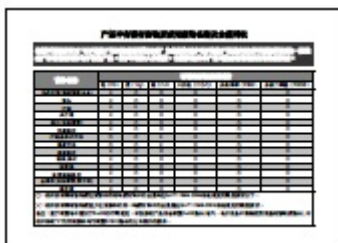

Certificate (China)



Projector Overview

Front-right View

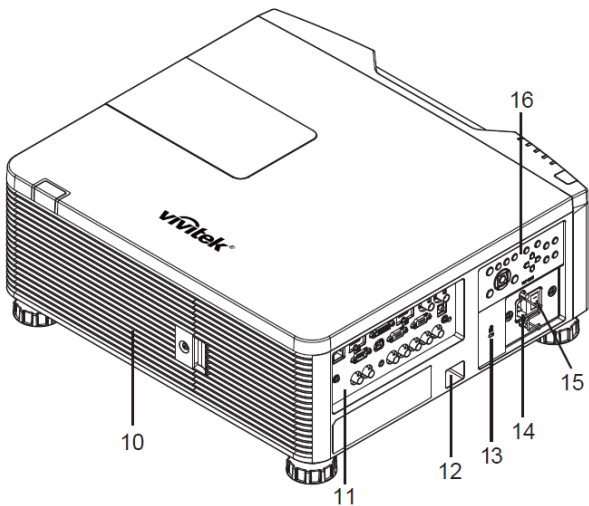
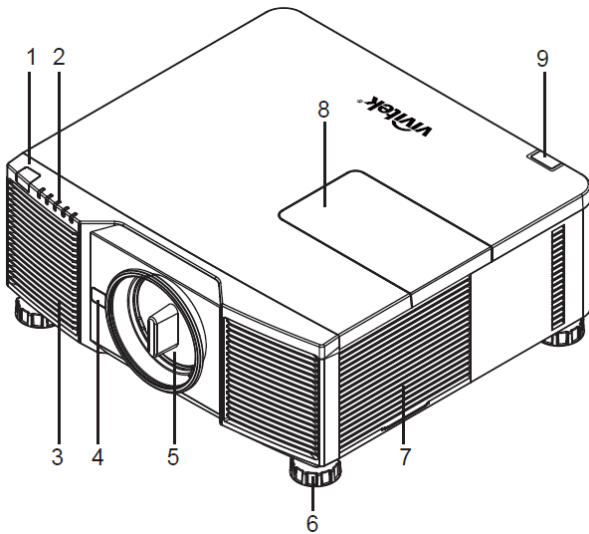

1. Front IR Receiver

The Receiver for IR signals from remote control.

2. LED Indicator

Display current projector status such as power, light source status and warning.

3. Air Intake

The fan pulls the cool air to the projector for system cooling.

4. Lens Release Button

Press the Lens Release button before removing the lens.

5. Lens hood

Remove the cover before installing the lens.

6. Height Adjuster

Adjust level of projector by four adjusters.

7. Intake Vent

The fans inside the projector suck the fresh air to cool the projector.

8. Color Wheel Cover

Remove the cover for replacing the color wheel module.

9. Rear IR Receiver

The Receiver for IR signals from remote control.

10. Vent

Heat is discharged from the projector via the vent. Make sure that the vent is not blocked by the object.

11. I/O Panel

Connect to various input, control or output terminals to the projector.

12. Security Chain Slot

Insert the security cable or wire commercially available into the security chain slot for preventing unauthorized removal of the projector.

13. Kensington Lock

Attach the projector to a permanent object with the Kensington slot.

14. AC Inlet

Connect the supplied power cable to this inlet.

15. AC Power Switch

Turn on/off the AC power of the projector.

16. Control Panel

Press the button to operate the OSD menu or adjust the lens settings, see OSD controls.



Warning:

- The air passes through grill openings on the projector is for good air circulation. Do not obstruct any of the grill openings and keep the required distance from any object



Note for color wheel door

- The product is with changeable color wheel feature; it can detect which kind of the color wheel is installed in the projector then switch to corresponding firmware for operation automatically. Please contact with your local dealer for ordering optional color wheel.
- The product is with sealed optical engine for

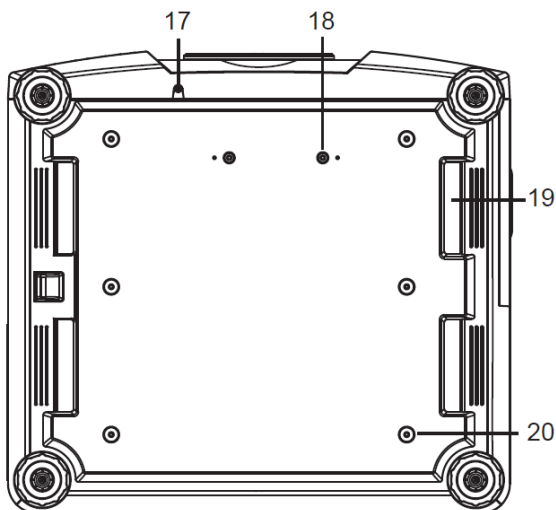

17. Anti-thief Screw hole

The anti-thief screw can be fastened to prevent Lens removing by unauthorized person.

18. Mounting Holes of Support Kit

These two screws holes can be used to fix support kits of ultra-short throw lens.

19. Recess for projector handling.

These four recesses can be used for handling the projector.

20. Ceiling Mounting Hole

These six screw holes are for ceiling mounting kits, (M4 screw, maximum depth 14mm)



Note:

- The screws are for Lens support kits only; overloading may damage the projector or cause injury.
- When installing, ensure that you use only UL Listed ceiling mounts, Contact your dealer for information on mounting the projector on a ceiling.
- With ceiling installation, use approved mounting hardware & M4 screws; maximum depth of screw 14 mm

IO Panel

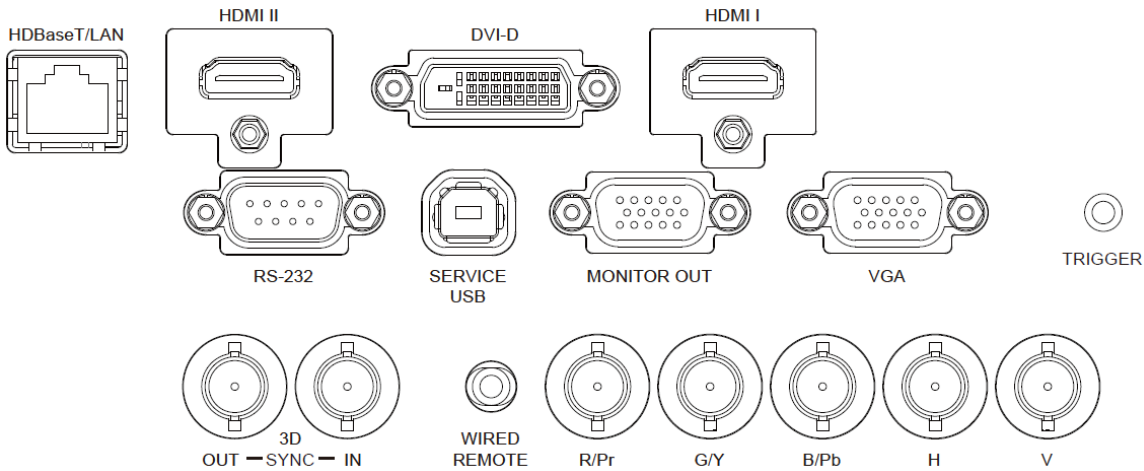

HDBaseT/LAN

Connect an Ethernet cable (Cat5/Cat6, not supplied) from a computer, network device, or HDBaseT transmitter.

HDMI II

Connect the HDMI cable from a computer or video device

DVI-D

Connect to DVI-D cable from a DVI-D output of the device.

HDMI I

Connect the HDMI cable from a computer or video device.

RS-232

The 9-pin D-sub interface is used to connect to the PC control system and projector maintenance.

Service USB

It is a port exclusively used for maintenance and only can be used by the authorized maintenance personnel.

MONITOR OUT

Connect to a monitor to display the projected content.

VGA

Provide the standard 15-pin VGA connection and can connect to RGB, HD Component or personal computer.

TRIGGER(12V +/-1.5V)

When connected to the screen through a 3.5mm cable, the screen deploys automatically on start-up of the projector. The screen reacts when the projector is powered off.

3D SYNC IN / Out

Connect to the 3D IR synchronization signal transmitter.

WIRED REMOTE

Connect the supplied remote controller to the projector

Component (V, H, B/Pb, G/Y, R/Pr)

Connect RGBHV or Component signal from computer or component video enabled device



Note for Trigger

- When the projector is turned on, a control signal (DC 12V) outputs from this terminal.
- Do not use this jack for anything other than intended use.



Note for Wired Remote Controller

- Please make sure whether the port for insertion is correct before the terminal of the wired remote control is inserted. The remote control may be damaged if inserted to the wrong port such as trigger. Do not use this jack for anything other than intended use

Control Panel

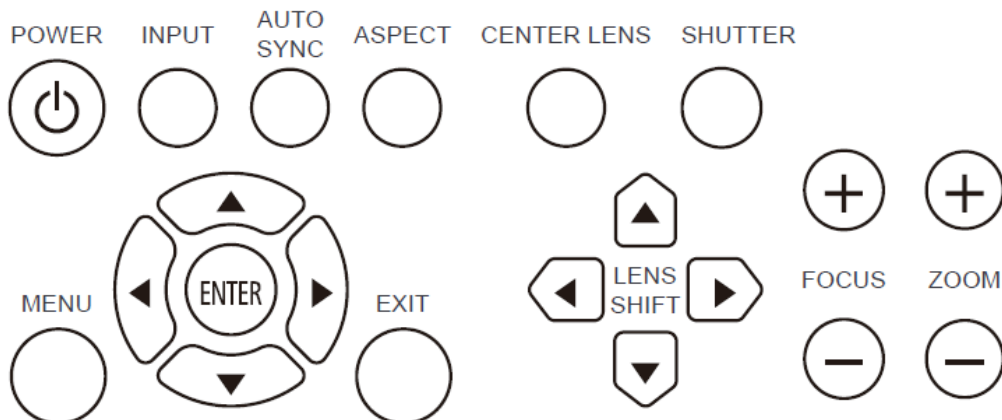

POWER

User the button to turn on/off the projector.

INPUT

Push the button to select the input signal. HDMI, DVI, VGA, Component...etc.

AUTO SYNC

Implement automatic signal synchronization.

ASPECT

Change the aspect ratio of the current image and push the button to change to the next aspect ratio settings.

MENU

Push the button to display or hide the OSD menu.

UP/Down/Left/Right

Use the button to select the OSD option.

ENTER

Use the button to select settings or confirm the changed settings.

EXIT

Push the button to return to the menu on the previous level or exit the OSD menu.

Remote Control

CENTER LENS

Push the button to center the lens and calibrate the parameter of lens shift, focusing and zooming.

Note: The lens memory function requires the accurate lens adjustment parameter. Please center the lens every time after the lens is mounted.

SHUTTER

Use the button to enable the light shutter for stopping the projection temporarily

LENS SHIFT

Use these four buttons to move the projected image to desired position.

FOCUS

Use the button to adjust the focus of projected image.

ZOOM

Use the button to zoom in/out the projected image.

Remote Control

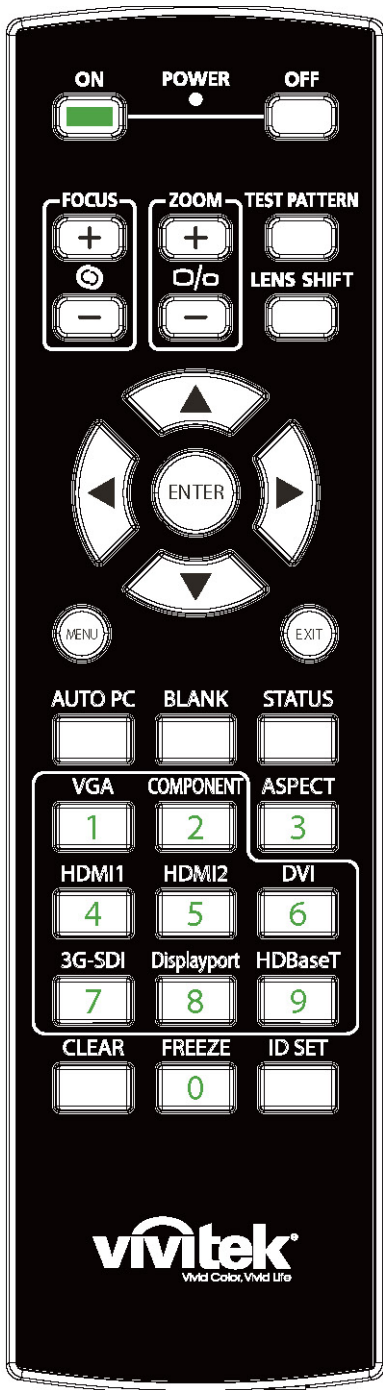

On

Use the button to turn on the projector.

OFF

Use the button to turn off the projector.

FOCUS

Adjust the focus of the projected image.

ZOOM

Zoom in/out the projected image.

TEST PATTERN

Use the button to show the test pattern. Press this button again to switch to the next pattern. Press the EXIT button to return to the projected image.

LENS SHIFT

Use the button to move the lens right or left.

ENTER

Use the button to select settings or confirm the changed settings.

MENU

Press the button to display or hide the OSD Menu.

EXIT

Press the button to return to the previous Menu or exit the OSD Menu.

AUTO PC

You can use this function to synchronize the VGA input signal automatically.

BLANK

Press the button to enable the shutter to temporarily interrupt the projection.

STATUS

Show OSD MENU – SERVICE.

VGA

Select VGA input source.

COMPONENT

Select Component input source.

ASPECT

Press the button to switch the aspect ratio.

HDMI1

Select HDMI1 input source.

HDMI2

Select HDMI2 input source.

DVI

Select DVI input source.

3G-SDI (Not Applicable).

DisplayPort (Not Applicable)

HDBaseT

Select HDBaseT input source.

CLEAR

Erase ID number stored in the remote control.

FREEZE

Freeze the projected image or resume the projection.

ID SET

Set ID number of the remote control.

Wired Remote Jack

Connect to WIRED REMOTE terminal on the projector

Remote Control Operating Range

The remote control uses infrared transmission to control the projector. It is not necessary to point the remote directly at the projector. Provided you are not holding the remote perpendicular to the sides or the rear of the projector, the remote will function well within a radius of about 10 meters (25 feet) and 15 degrees above or below the projector level. If the projector does not respond to the remote control, move a little closer.

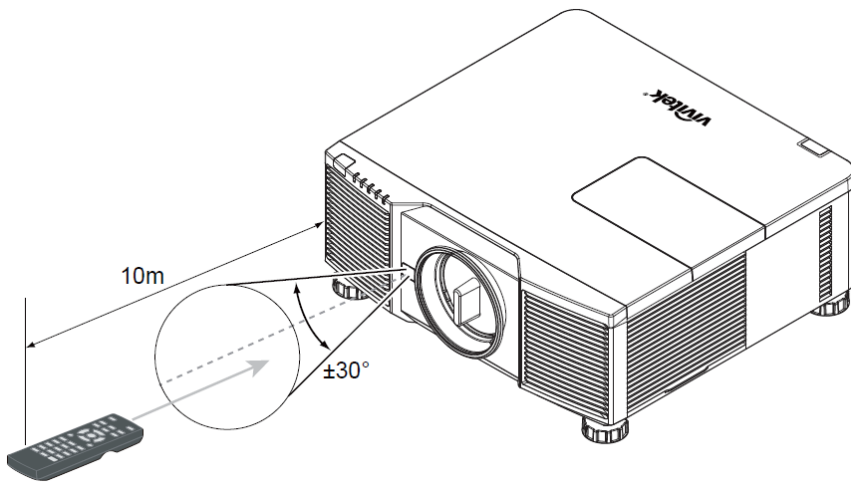

Installation and Setting up the Projector

Inserting or Replacing the Remote Control Batteries

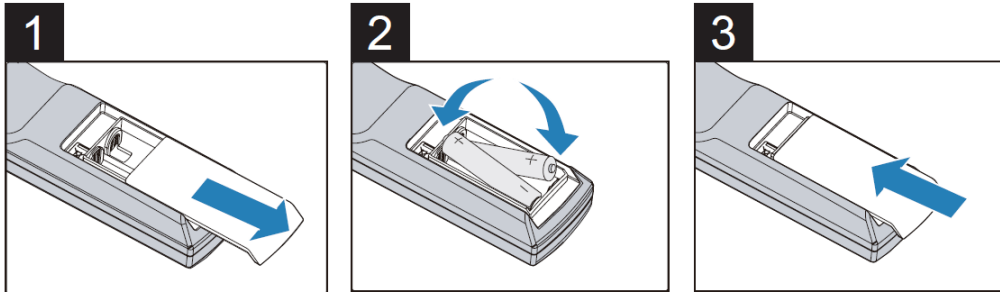

1. Remove the battery compartment cover by sliding the cover in the direction of the arrow.
2. Place two AA batteries with the correct polarity.
3. Slide on the cover as the arrow in the illustration.



Note:

- Avoid using the projector with bright fluorescent lighting turned on. Certain high-frequency fluorescent lights can disrupt remote control operation.
- Be sure nothing obstructs the path between the remote control and the projector.
- Do not expose the remote control to high temperature or humidity; otherwise, the remote control will not work functionally



Battery installation instructions

- Make sure the battery is installed with the correct polarity
- Do not use the old and new batteries or the batteries of different types together
- Remove the battery if the remote control may not be used for a long time to prevent the damage caused by leaks

Installing the Projector

The high quality display effect can be guaranteed only when the projector is correctly installed. Generally, the light source facing the screen should be reduced or eliminated as much as possible. The contrast of the image will be obviously reduced if the light directly shines on the screen, such as the beam from windows or the searchlight cast on the image. The image may become faded and not bright. Before installation, recommend to eliminate the effect of ambient light. Beside the projection performance, please read below precaution for installation carefully.

Precautions for Installation



- Projector installation must be done by a qualified professional. Contact your dealer for more information. It is not recommended you install the projector yourself.
- With ceiling installation, use approved mounting hardware & M4 screws; maximum depth of screw: 14 mm. Contact your dealer for information about mounting the projector on a ceiling.
- Only use the projector on a solid, level surface, serious injury and damage can occur if the projector is dropped



- Ensure that the hot air from the exhaust vent is not sucked into the projector.
- Ensure the air intake and exhaust vents are unobstructed and keep the required distance from any object. Below is required minimum distance between the vent and any object.
- All added enclosures should pass a certified thermal evaluation to ensure that the projector does not recycle exhaust air, as this may cause the projector to stop projection even if the enclosure temperature is with the acceptable operation temperature range.

Airflow and Heat Emission

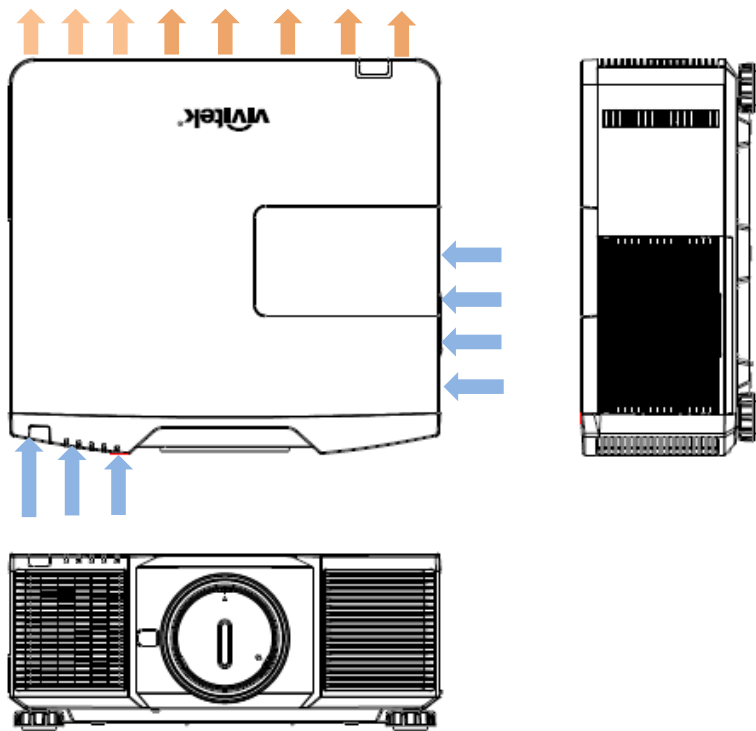

Minimum Distance to Vent

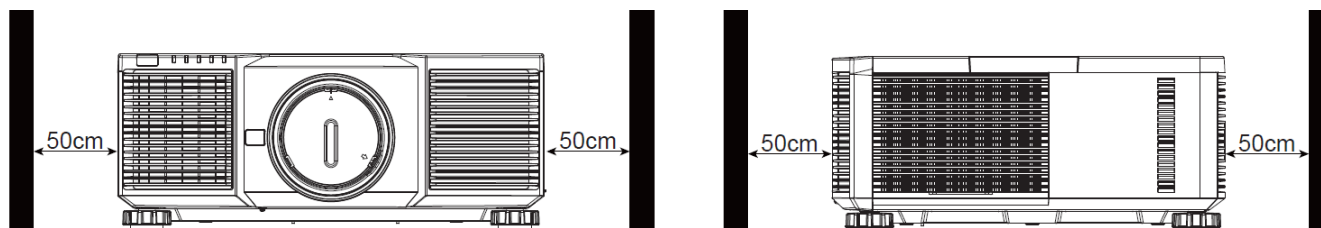

Mounting the Projector

For mounting the projector, please use UL Listed ceiling mounts and M4 screws, maximum depth of screw: 14 mm.

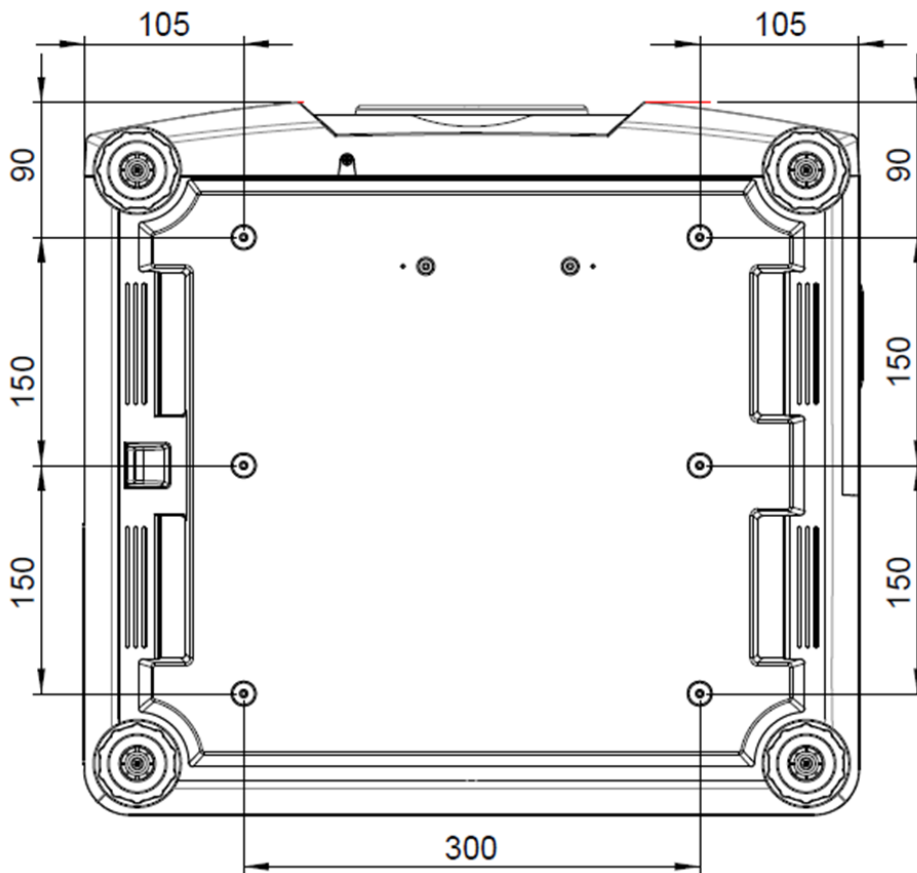

- Only use the projector on a solid, level surface, serious injury and damage can occur if the projector is dropped.
- Please do not stack the projector on the surface of another projector, serious injury and damage may occur if the projector is dropped

Installing or Removing the Optional Lens

CAUTION



- Before removing or installing the lens, be sure to turn off the projector and wait till the cooling fans stop, and turn off the main power switch.



- Do not shake or place excessive pressure on the projector or the lens components as the projector and lens components contain precision parts.
- Be sure to remove the optional lens before shipping the projector. The lens and the lens shift mechanism may encounter damage caused by improper handling during transportation.
- Do not touch the lens surface when removing or installing the lens.
- Keep fingerprints, dust or oil off the lens surface. Do not scratch the lens surface.
- Work on a level surface with a soft cloth under it to avoid scratching.
- If you remove and store the lens, attach the lens cap to the projector to keep off dust and dirt.
- When installing the lens into the projector, be sure to remove the lens cap from the back of the optional lens, the cap would block the light and be melted. Failure to do so will cause damage to the projector and lens.

Install New Lens

1. If the Lens cover is installed, pull the edge of the lens cover with one hand (①), so that the lens cover can be removed easily with the other hand (②)

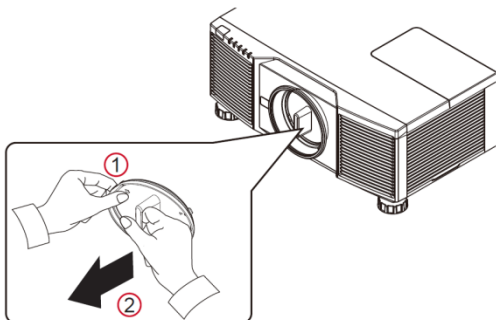

2. Align the "↑" symbol on the lens label with the "*" symbol on the top of the body (align to the center of the lens hole) and pull in the lens.

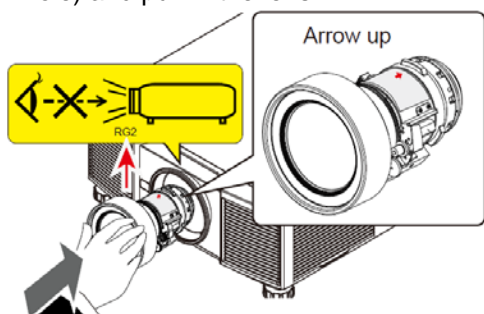

3. Make sure the lens is pushed into the holder and turn it clockwise to the "Lock" position. When turning the lens, the "Click" sounds twice to indicate that the lens is completely fixed.

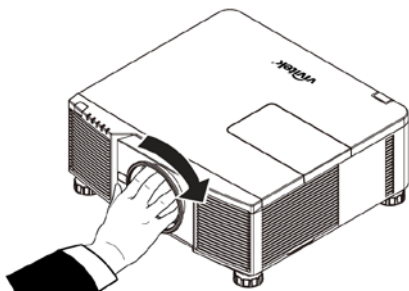

4. Check if the lens is fixed successfully by pulling the lens out of the holder gently.

Removing the Existing Lens

1. Push the LENS RELEASE button all the way in and rotate the lens counterclockwise. The existing lens will be disengaged

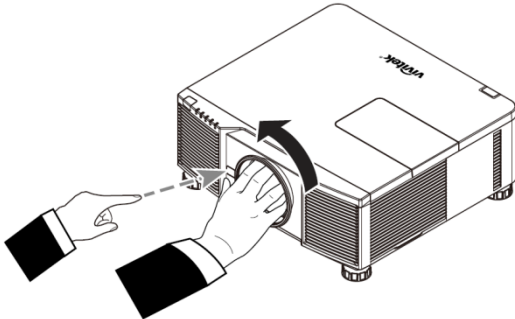

2. Pull out the existing lens slowly.

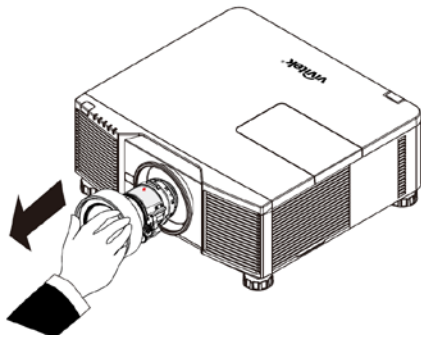

- Please check if Release button is locked by the screw if the button can't work.

Turning on the Projector

The AC power cord is included in the box; plug the power cord to the AC socket on the IO panel.

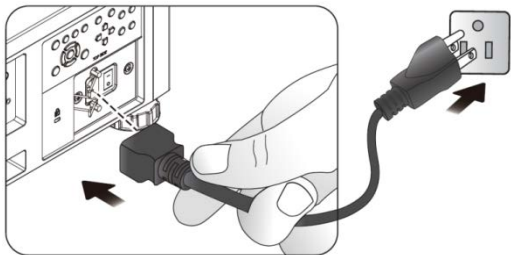

Once the projector is correctly located and the power cable and other connections are in place, it is important that the projector is powered on correctly in order to avoid damage to components and un-necessary wear and tear. Refer to the following guide to power on the projector.

1. Press the main power switch to the on (I) position as shown. POWER LEDs flashes then lights red.

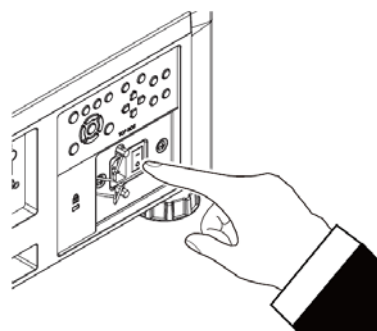

2. Press the POWER button on the control panel or ON button on the remote control.

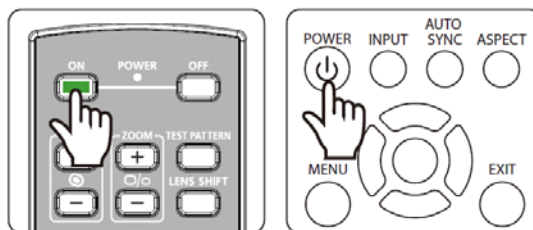

3. The Power LED and LIGHT LED flashes green till power on process is finished.

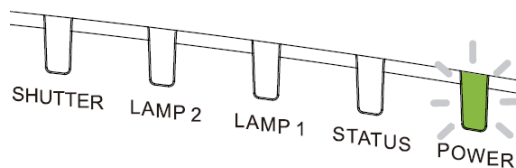

4. After few seconds, both LEDs keep green, the projector is ready for use.

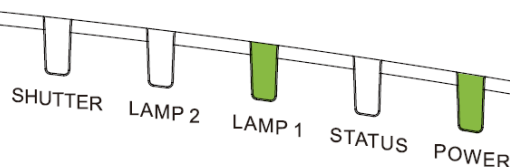

Turning off the Projector

Once the projector is no longer required, it is important to shut it down correctly to avoid damage or unnecessary wear and tear to the projector.

CAUTION



- Do not unplug the power cable from the wall outlet or projector when the projector is powered on. Doing so can cause damage to the AC IN connector of the project or the prong plug of the power cable. To turn off the AC power supply when the projector is powered on, use a power strip equipped with a switch and a breaker.



- Do not turn off the AC power supply within 10 seconds after making adjustment or changing the setting. Doing so is possible to cause loss of adjustments and settings and return to default.

Refer to the following guide to turn off the projector.

- Press the POWER button on the control panel or OFF button on the remote control once, the Power Off window displays.

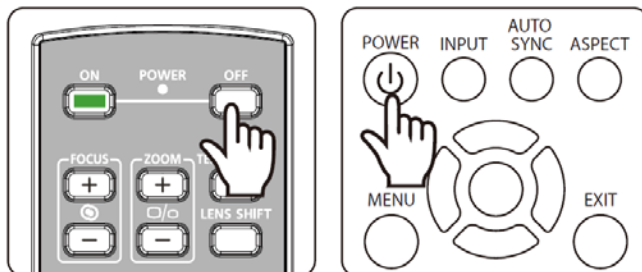

- Press the POWER button again on the OSD control panel or remote control to verify power off, the power LED flashes orange after Power Off is confirmed.

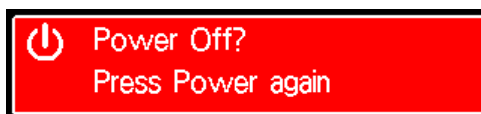

- The projector enters Standby mode when the power LED lights red.
- Press the Main Power switch to the off position (O) to turn off the projector.

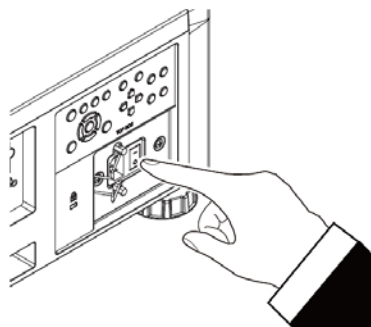

Setting up the Cooling Condition

The high quality display effect can be guaranteed only when the projector is correctly installed. Generally, the light source facing the screen should be reduced or eliminated as much as possible. The contrast of the image will be obviously reduced if the light directly shines on the screen, such as the beam from windows or the searchlight cast on the image. The image may become faded and not bright.

Beside projection performance, the installation orientation would affect heat dissipation for the projector. Improper cooling conditions may shorten the life of light source or damage the components inside the projector. Please set the correct Cooling Condition on OSD menu according to the installation orientation.

The available installation options as below.

Table: Install the projector on the table and project the image within 60 degree as below illustration

Ceiling: Mount the projection on the ceiling and project the image within 60 degree as below illustration

Upward: Project the image upward or the installation angle the angle is over 60 degree as below illustration.

Downward: Project the image downward or the installation angle the angle is over 60 degree as below illustration.

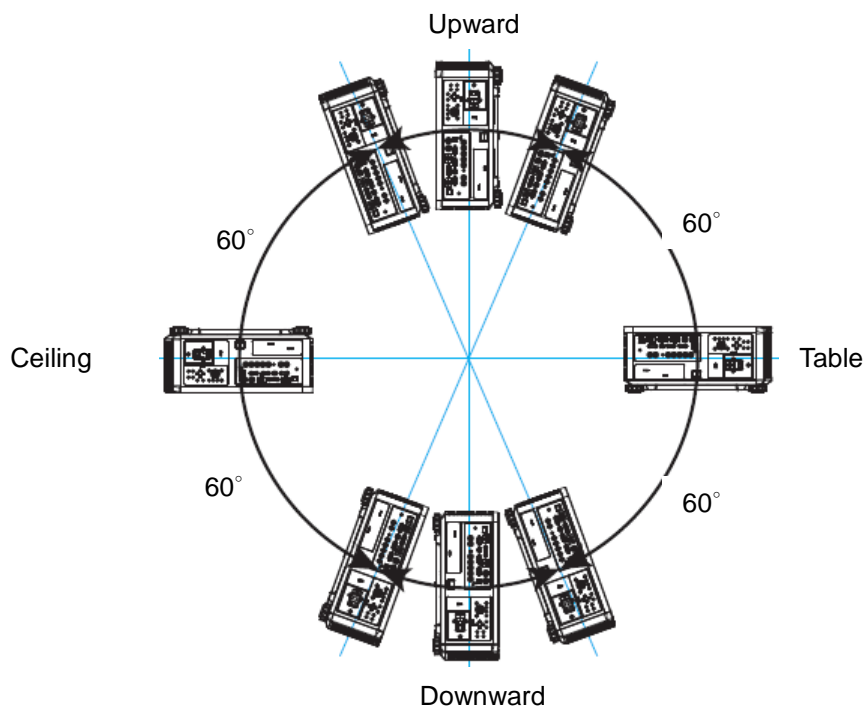

Setting up the Projection Mode

The projection mode option can be used to change the orientation of the projected image or flip the projected image.

Desktop Front: Install the projector on the table and project the image on the screen forward.

Ceiling Front: Mount the projector on the ceiling and project the image on the screen forward, the image is overturned.

Rear Desktop: Install the projector on the table and project the image from the rear of the screen.

Rear Ceiling: Mount the projector on the ceiling and project the image from the rear of the screen, the image is overturned.

Adjusting Projected Image Position

The projector has the powered lens shift feature; the image can be shifted vertically or horizontally without moving the projector. The lens shift range is shown in the percentage of the screen height and width, the maximum vertical shift range can be up to 64% of the projected image height and down to 33% of the height, and maximum horizontal shift range is 24% of the image width to right, 14% of the image width to the left. Please refer to below illustration.

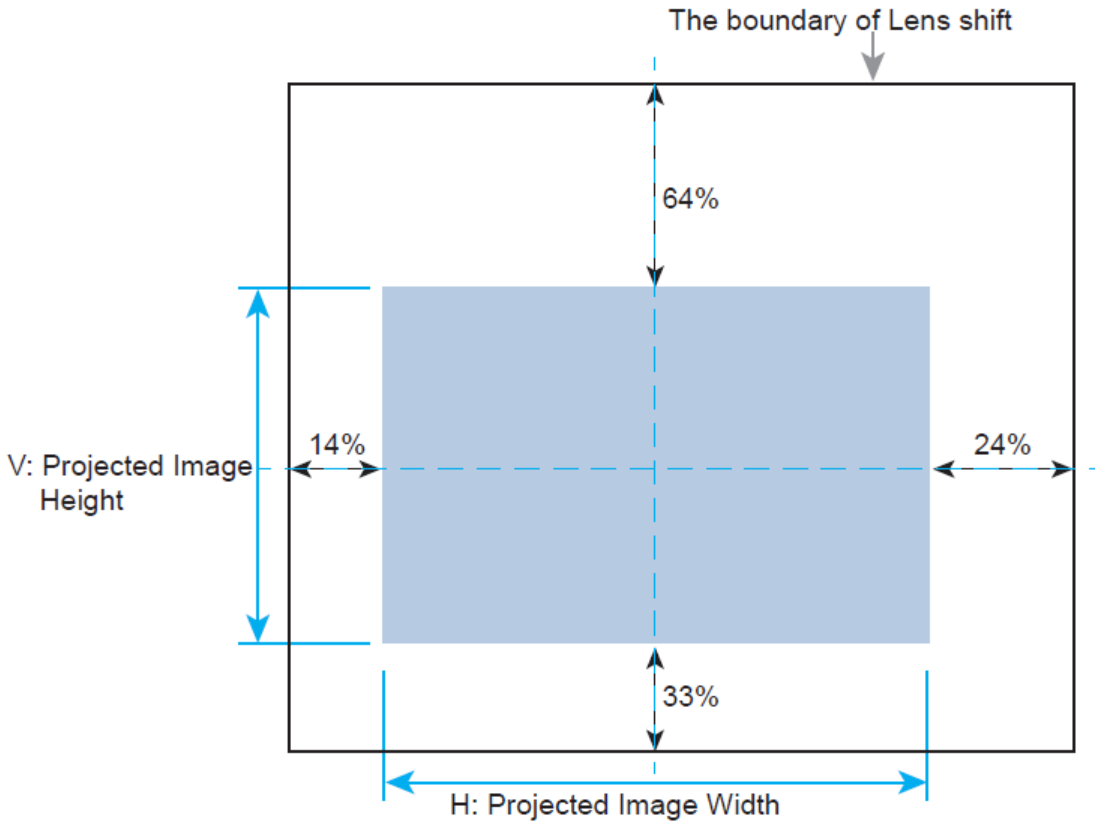

-  There is a Lens Lock function on OSD menu to disable lens control adjustment for avoiding possible misoperation after you finish the adjustment, please make sure to disable the lock before performing the lens control.

Adjusting the Focus and Zoom

The focus and zoom can be adjusted from the projector control panel or remote control. Refer to the following guides to adjust the focus and zoom manually.

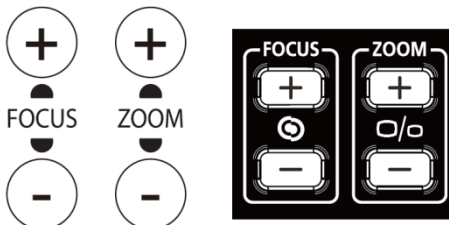

Press the Focus or Zoom button on the control key panel or remote control to adjust the focus or zoom effect using the increase and decrease buttons as required

Correcting Keystone Distortion

When the image is projected either from the top or from the bottom toward the screen at an angle, the image becomes distorted. Use Keystone function to correct the distortion, the adjustable range is approximately +/-30 degree. The following are conditions under which the maximum angle is achieved:

- When the standard lens is used.
- When the lens shift is set to the center point.
- The mage is projected in Wide mode.

Select the Keystone adjustment then use ◀ or ▶ to correct the distortion, the adjustable value in horizontal and vertical direction is ±30. The illustration is as below.

Horizontal Keystone:

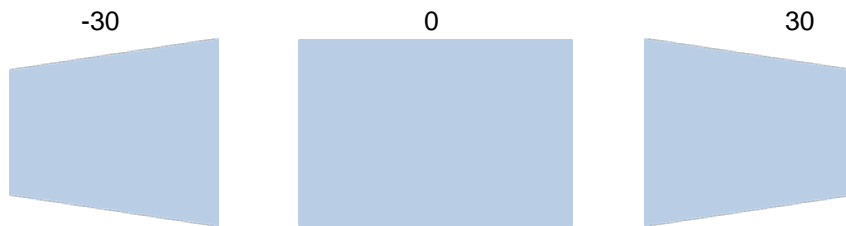

Vertical Keystone:

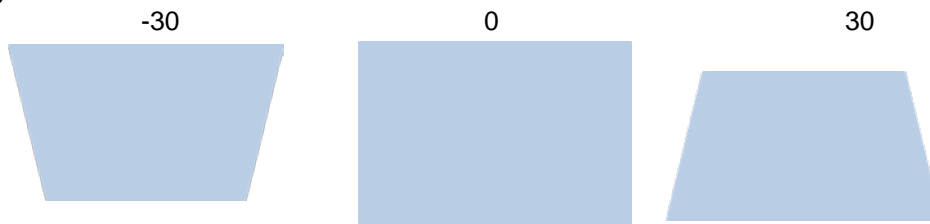

Beside correcting keystone H and V Keystone by separate, you can use H and V keystone combination to correct the distortion. In this case, the effective range may be limited.

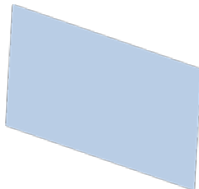

- You can correct the geometry distortion either by Keystone or Corner Adjustment function, only one correction can be used for projected image. When one of two functions is used, the setting by another function will be reset.

Correcting Distortion at the Corner

This function allows you to adjust the individual corner as below figure

Horizontal direction of the corner



Vertical direction of the corner



Horizontal and vertical direction of the corner



Follow below steps to adjust the corner

1. Select Corner Adjustment option on Installation page.
2. Use ▲ or ▼ to enter the Corner Adjustment page then press the arrow button to select the corner

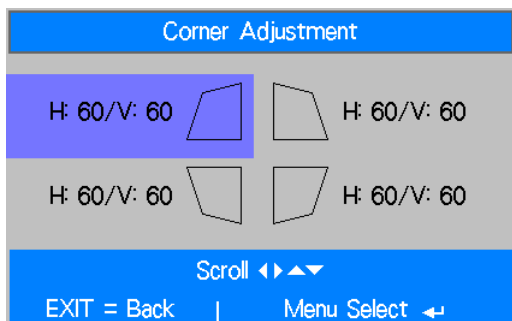

3. Press Enter button then use ▲ or ▼ to adjust vertical direction of the corner and ◀ or ▶ to adjust horizontal direction of the corner.

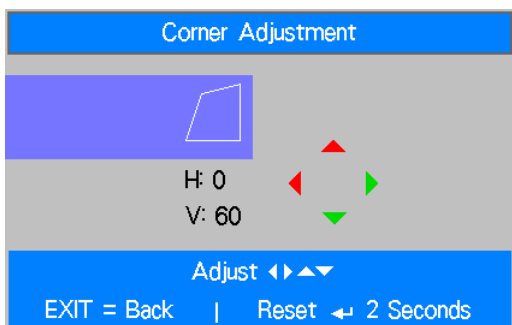

4. Press and hold the Enter button around 2 seconds to reset the corner adjustment.

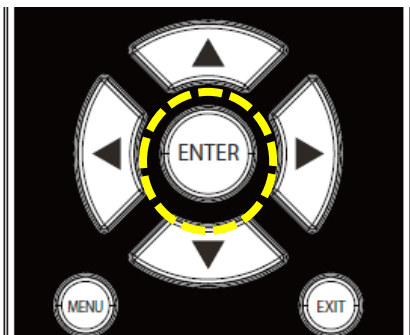

5. Press Exit to return to last menu or MENU button to close the menu.

Using Control ID for Multi-projector Application

When installing more than one projector in the room, the projectors may receive the control signal at the same time. In this case, you can use control ID function to specify the identification of the projector and remote control to operate the specified projector. Follow below steps to set up the identification number for the projector and remote control.

Set the Projector identification number

1. Enable Projector ID Control function from SETUP->Advance menu as below figure

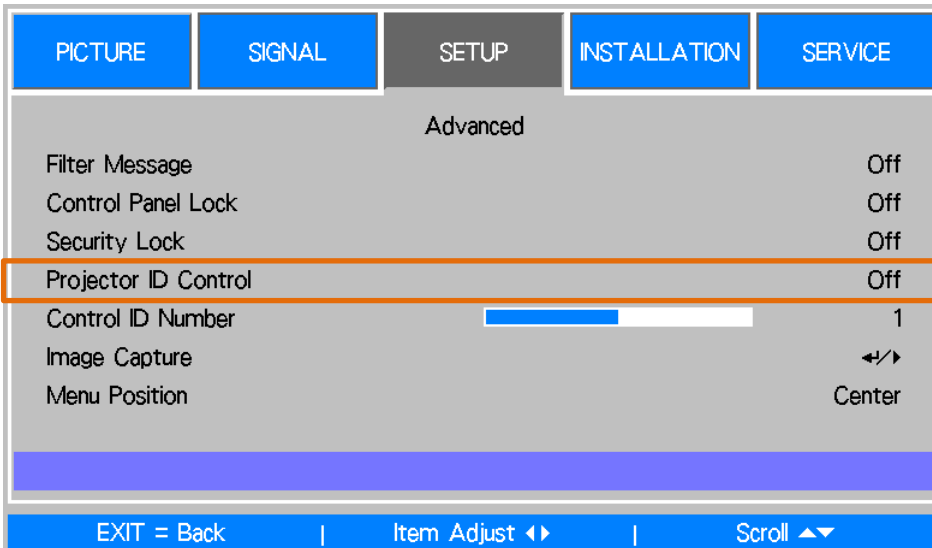

2. Set Control ID Number

Select Control ID Number option then use ► button to increase the number or ◀ button to decrease the number. This option is available when Projector ID Control is turned on.

Set the identification number of remote control

Press and hold ID SET button on the remote control around 5 seconds, Power led indicator is flashing red periodically. Press two digits to set desired ID number, each pressing shall be leisurely. Power LED will flash on time when the remote control is confirmed the setting.

Press and Hold ID SET button around 5 seconds



Power LED is flashing

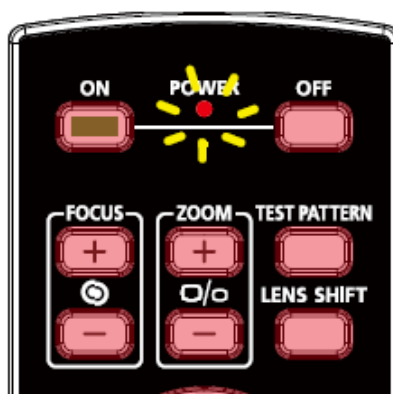

Press two digits for ID number



- Set the identification number will overwrite the ID number you set, you can set the ID number directly if you would like to give new ID number for the remote control.

Erase the identification number of the remote control

The set ID number is overwritten if new ID number is set, you can press ID SET and CLEAR button to erase ID number of the remote control

Press ID SET and CLEAR buttons simultaneously



The backlight of the buttons is flashing one time



Checking the identification number of the projector and remote control

The identification number of the projector and remote control can be checked by SERVICE menu as below figure, "X" represents that the function is not enabled; the number 26 is the current identification number of the remote control

PICTURE	SIGNAL	SETUP	INSTALLATION	SERVICE
Model :		DU6771		
Serial Number :		WDU67711703006		
Software Version :		MP01-0D06-LD06-RE04-SP03-PD06-9B04-3090		
Control / Remote ID :		X / 26		
Lamp Status		↔/▶		
Source Information		↔/▶		
Usage Time		↔/▶		
Filter Timer Reset		↔/▶		
Factory Reset		↔/▶		

EXIT = Back | Item Adjust ◀▶ | Scroll ▲▼



- Project ID Control function is available when the option is turned on and remote control wire is not plugged into the wire remote jack.
- Projector can receive any control signal from the remote control with various ID numbers if Projector ID Control is set to Off. Please turn on Projector ID Control for specified projector.

Preventing the Unauthorized Use of the Projector

Using the Control Panel Lock

This function allows you to lock control panel on the projector for preventing the unauthorized operation on control button.

Locking the control buttons

Select SETUP > Advance >Control Panel Lock to enable the function as below illustration.

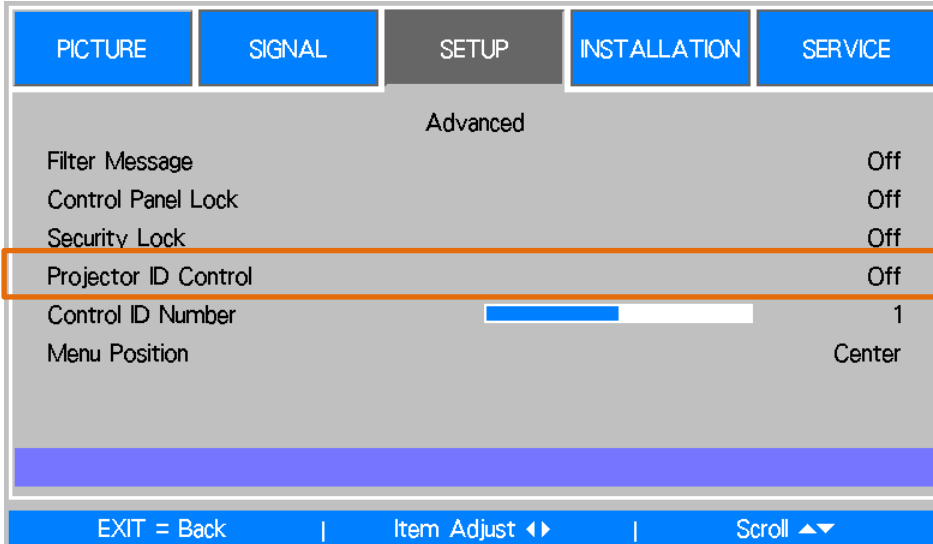

The pop-up message will be shown as below if Control Panel Lock is turned on, all of control buttons on the remote control are locked.

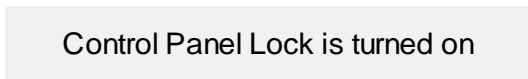

Unlocking the control panel

Once Control Panel Lock is enabled, all of control buttons on the projector are disabled, use the remote control to select OSD SETUP > Advance >Control Panel Lock to Off for unlocking the control panel.

Using Security Lock

This function allows you to lock the projector for preventing the unauthorized turning on the projector; the setting is valid when you turn on the projector next time.

Enable the Security Lock

Select SETUP > Advance >Security Lock then select On to enable the function as below illustration.

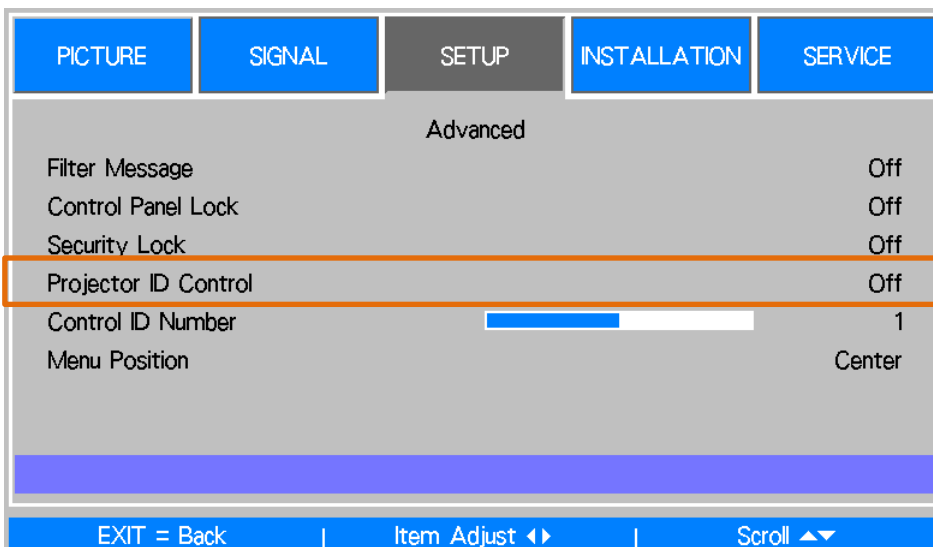

Once Security Lock is turned on, the pop-up message for setting up the password Lock as is shown as below. Press

arrow buttons to set up your password, the password can be the combination of four arrow keys.

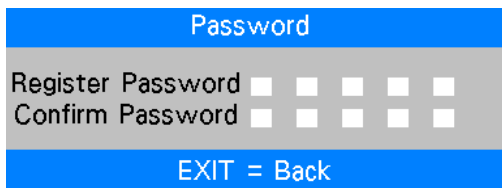

Control Panel Lock is turned on, the pop-up message will be shown Lock as below, select OK to confirm or Cancel to ignore the setting.

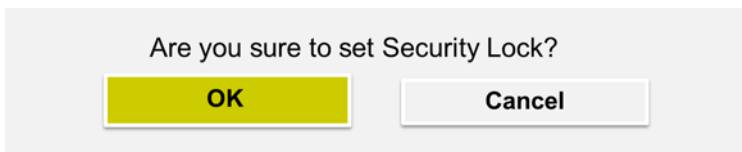

When you turn on the projector next time, the pop-up window will remind you to input the password to start the projection.

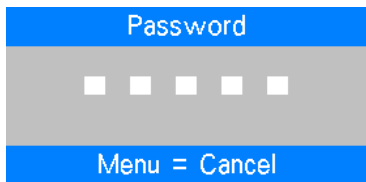

Unlocking the projector

The projector can be unlocked from OSD menu, enter OSD menu SETUP > Advance > Security Lock to switch the option to Off.

Using the Screw to Lock the Projection Lens

There is one anti-thief screw in the accessories box; the screw can lock the Lens Release button to prevent the unauthorized removing lens. Once the projection lens is fixed by the screw, the lens release button is disabling till the screw is detached.

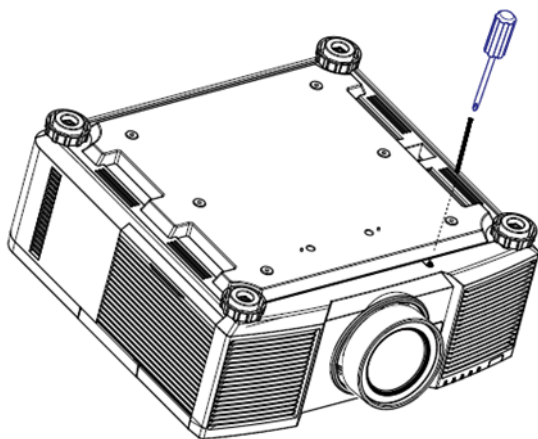

- Please check if Release button is locked by the screw if the button can't work.

Making Connections

Follow the instructions below to connect the projector to the video source, external control equipment (if any). When connecting to the equipment, use the correct signal cable to connect to the signal source and ensure that the cable is securely connected. Fasten the nut on the joint and connect the signal source equipment to the projector according to the figure below.

Connecting to Personal Computer

You can connect the PC signal to be projected to the projector through the DVI-D, HDMI, VGA or RGBHV (BNC) cable. If the signal to be input is VGA signal, connect the VGA cable to the external display to simultaneously monitor the projected content.

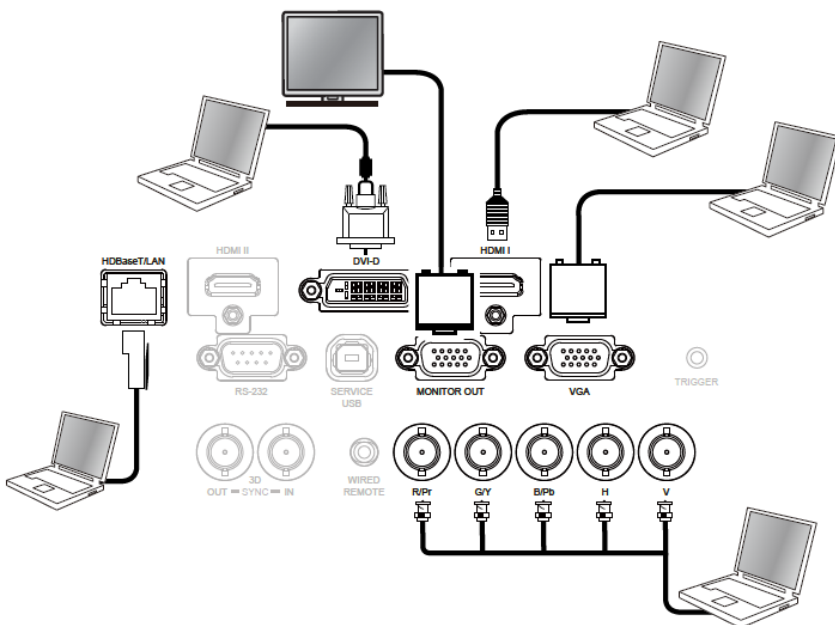

Connecting to the Video Device

Connect the video equipment to the input port of the projector via the DVI-D, HDMI, Component Video, Composite Video or S-Video Connector.

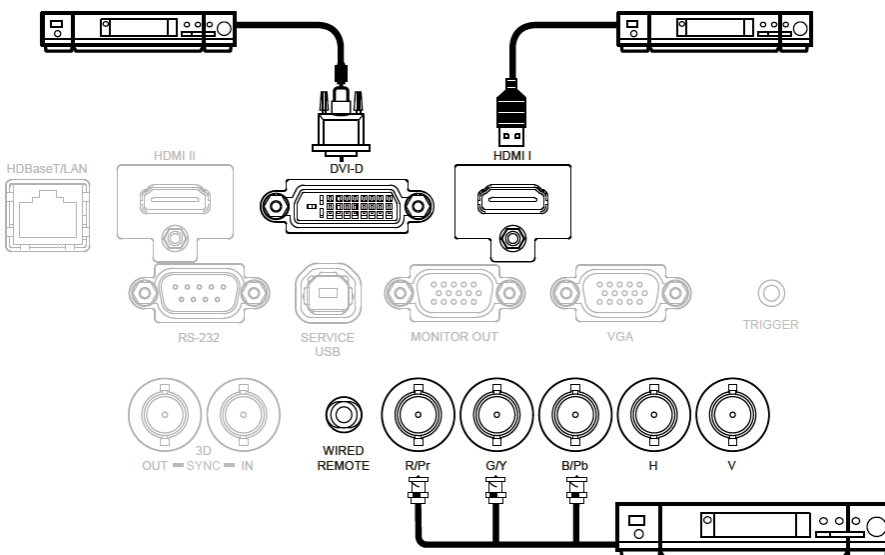

Connecting to the Control Equipment

The projector has the following control port for connecting to the control equipment:

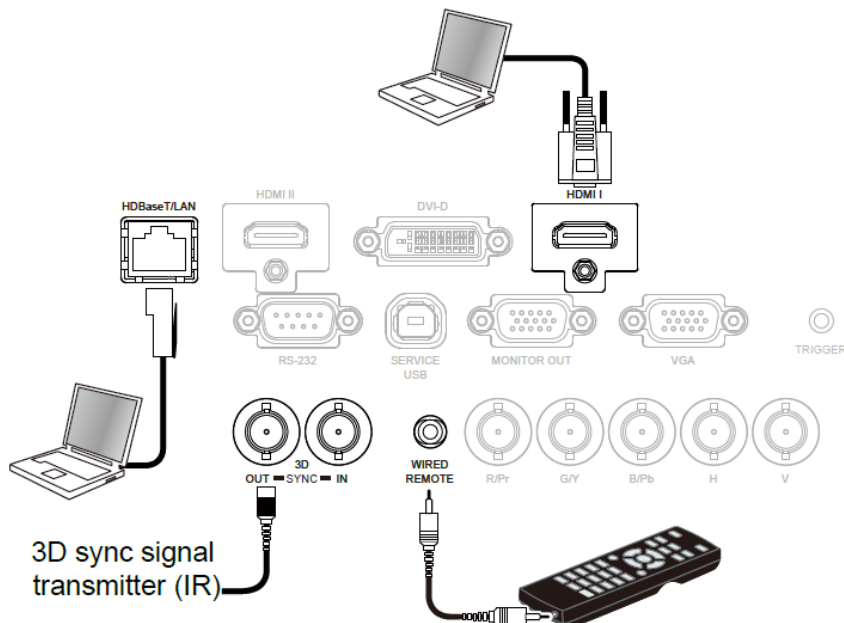

HDBaseT/LAN (Network control): The projector supports network control. LAN and HDBaseT share the one port. If only network control is used, you can connect the LAN on the projector to PC or through the local network. Refer to the Remote Communication Manual for detailed information.

RS-232 (RS-232 control): The projector can be remote-controlled by connecting the projector to PC or control system through the standard 9-pin serial cable (Straight Through Serial Cable). Refer to the Remote Communication Manual for detailed information.

Wired remote control: If the projector cannot receive the IR signal from the remote control due to the overly long distance or obstacles, you can connect the cable to the IR remote control or the external IR transmitter (optional) via the WIRE input port to expand the working range of the remote control.

3D Sync Out/In: Connect to 3D IR sync signal transmitter or device.



- When the terminal of the remote control cable is inserted to the wired control terminal of the projector, the projector will automatically switch to the wired control mode and cannot be controlled through the IR signal of the remote control. Disconnect the wired control terminal on the projector if you want to control through the IR signal of the remote control.
- Projector ID Control is disabled when wire remote control is used.
- If the wired remote control cable or the external IR transmitter is inserted to the incorrect port, such as Trigger, the remote control or the IR transmitter may be damaged. Make sure whether the port is correct.

Connecting to the Screen Trigger

If your projection system includes the electric projection screen and other 12V trigger device, you can connect these devices to the 12V trigger to output and configure the output 12V signal settings. The projector will output 12V signals for trigger when it's turned on. You can use the signal to control the screen or device.

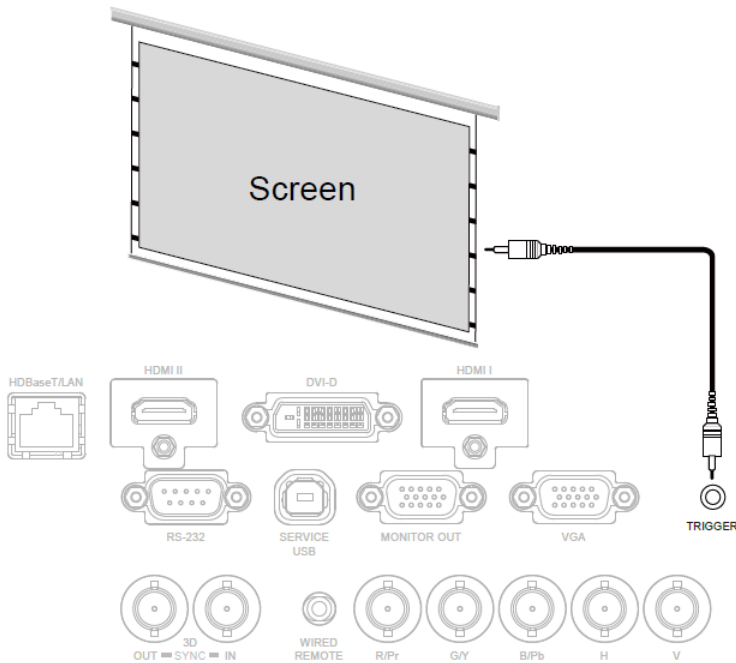

Connecting to External HDBaseT Transmitter

The projector has a built-in HDBaseT receiver. With HDBaseT Transmitter (optional), the video, RS-232 and LAN signals can be sent to the projector via a single RJ-45 cable. If the HDBaseT Transmitter you purchased supports the input and output of the IR remote control, the control signals from the IR remote control can be sent to the projector via the RJ-45 cable.

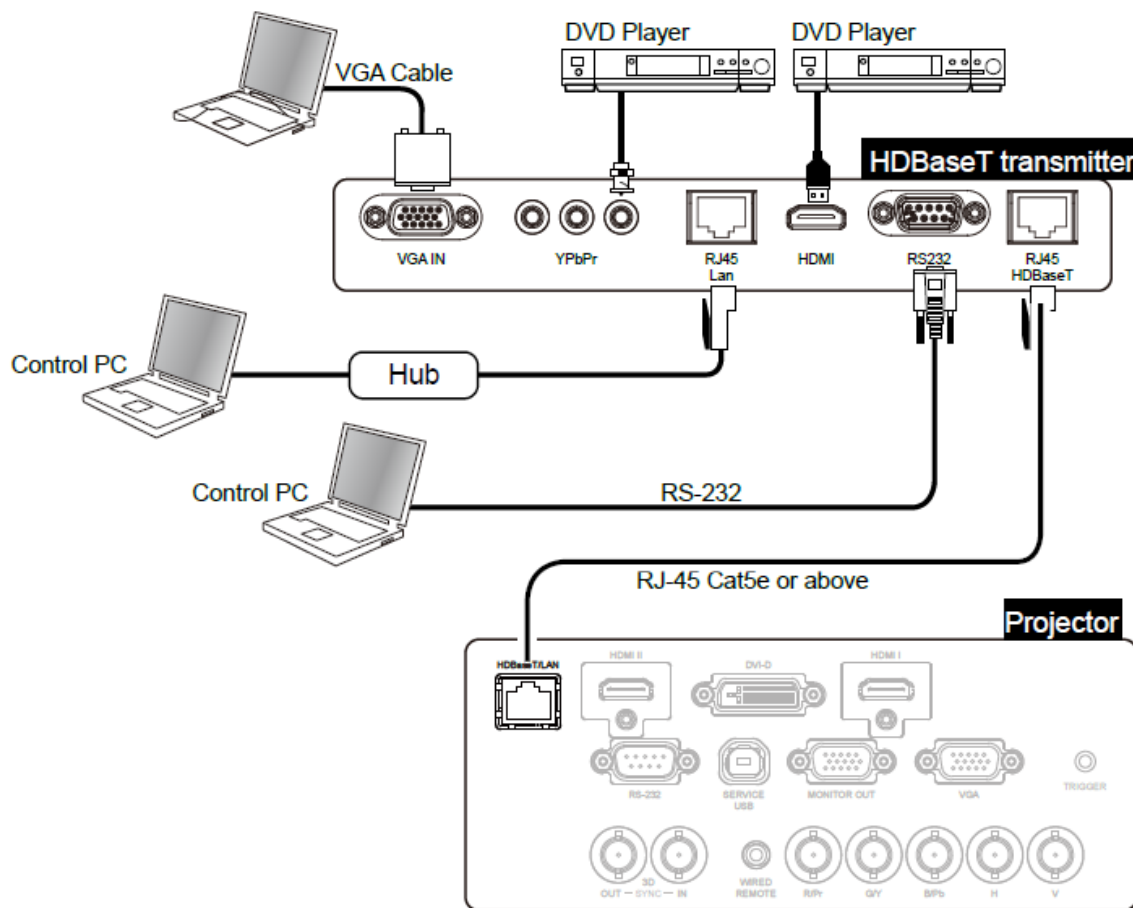

- 
- The projector supports the video signal, R-232, IR remote control and the reception of the network control signals but do not support Power over Ethernet (PoE).
- The baud rate will be switched to 9600 automatically if RS232 command is sent via external HDBaseT transmitter.
- If the command is sent via the HDBaseT transmitter, the longest transmission distance is 100 meters. The projection may be interrupted or interfered, or the control signal cannot be sent if the transmission distance is exceeded.
- Use the RJ-45 Cat5e or above cable and avoid entwining. Entwining may cause damage or interfering signal transmission, reduce the transmission distance and degrade the image quality.

Using the projector

Using On-Screen Display

The projector has an On-Screen Display (OSD) that lets you make image adjustments, change various settings and check current projector status.

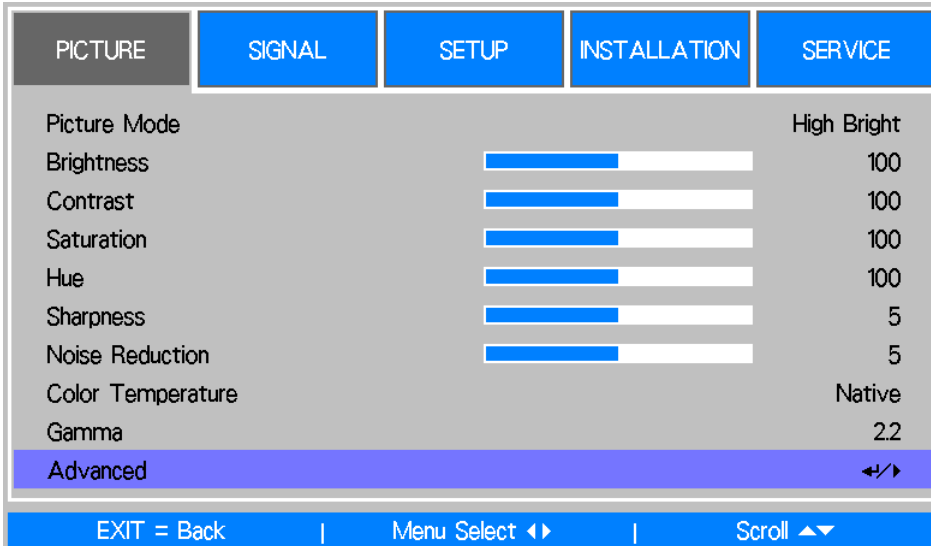

Navigating the OSD

You can use the remote control or the control buttons on the projector to navigate and make changes to the OSD. The following illustration shows the corresponding buttons on the remote control and on the projector

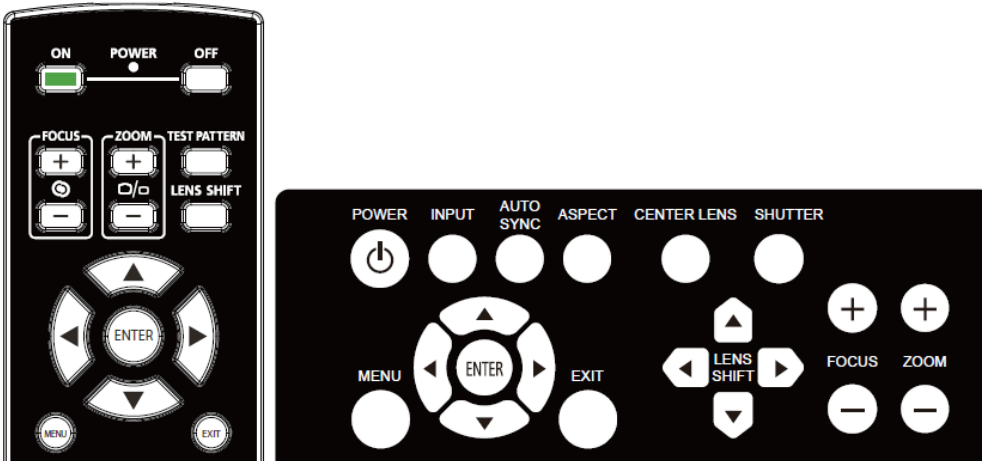

1. To open the OSD, press the **Menu** button on the OSD control panel or remote control. There are five folders on the menu. Press the cursor ◀ or ▶ buttons to move through secondary menus.
2. Press ▲ or ▼ to select menu items and ◀ or ▶ to change values for settings. Press ◀ to confirm the new setting.
3. Press **RETURN** to leave a submenu or **MENU** to close menu



Menu Tree

Use the following table to quickly find a setting or determine the range for a setting.

Main Menu	Submenu				
Picture	Picture Mode	High Bright			
		Presentation			
		Video			
	Brightness				
	Contrast				
	Saturation				
	Hue				
	Sharpness				
	Noise Reduction				
	Color Temperature	Native			
		5400K			
		6500K			
		7500K			
		9300K			
	Gamma	1.0			
		1.8			
		2.0			
		2.2			
		2.35			
		2.5			
S Curve					
Advance	Input Balance	Red Offset			
		Green Offset			
		Blue Offset			
		Red Gain			
		Green Gain			
	HSG	Blue Gain			
		Red	Hue/Saturation/Gain		
		Green	Hue/Saturation/Gain		
		Blue	Hue/Saturation/Gain		
		Cyan	Hue/Saturation/Gain		
		Magenta	Hue/Saturation/Gain		
		Yellow	Hue/Saturation/Gain		
		White	Hue/Saturation/Gain		
		Reset			
Signal	Input Selection	HDMI I			
		HDMI II			
		DVI-D			
		VGA			
		Component/BNC			
		HDBaseT			
	EDID Mode	HDMI I			
		HDMI II			
		DVI-D			
		VGA			
		Component/BNC			
		HDBaseT			
Auto Search	Off				
	On				
Color Space	Auto				
	YPbPr				
	YCbCr				
	RGB-PC				
	RGB-Video				
Aspect Ratio	5:4				

Main Menu	Submenu		
		4:3	
		16:10	
		16:9	
		1.88:1	
		2.35:1	
		Letterbox	
		Auto	
		Native	
	Overscan	Off	
		On	
	Background	Logo	
		Black	
		Blue	
	Test Pattern	White	
		Black	
		Red	
		Green	
		Blue	
		Checker Board	
		Crosshatch	
		H Burst	
		V Burst	
		Color Bar	
	VGA Setup	H Total	
		H Start	
		V Phase	
		V Start	
	Auto Sync	Execute	
Setup	Language	English	
		François	
		Español	
		Deutsch	
		Português	
		简体中文	
		繁體中文	
		日本語	
		한국어	
	Lamp Mode	Dual	
		Single	
		Lamp1	
		Lamp2	
	Lamp Power	Normal	
		Eco	
		Custom Power Level	
	Custom Lamp Power		
	Startup Logo	On	
		Off	
	Digital Alignment	Digital Zoom	
		Digital Pan	
		Digital Scan	
		Reset	
	Trigger	On	
		Off	
	Dynamic Black	On	
		Off	
	3D	3D Format	Off
			Auto
			Side by Side
			Top/Bottom

Main Menu	Submenu			
			Frame Sequential	
		DLP Link	On	
			Off	
		3D Swap	Normal	
			Reverse	
		3D 24Hz Display	96Hz	
			144Hz	
		Sync Reference	Internal	
			External	
	Advanced	Sync Delay		
		Filter Message	Off/100H/200H/500	
			H/1000H	
		Control Panel Lock	On	
			Off	
		Security Lock	On	
			Off	
		Projector ID Control	Off	
			On	
		Control ID Number		
		Menu Position	Top Left	
			Top Right	
			Bottom Left	
			Bottom Right	
			Center	
Installation	Projection Mode	Desktop Front		
		Desktop Rear		
		Ceiling Front		
		Ceiling Rear		
	Cooling Condition	Table		
		Ceiling		
		Upward		
		Downward		
	High Altitude	On		
		Off		
	Standby Mode	Network Standby		
		Eco		
	Remote Sensor	Front/Rear		
		Front		
		Rear		
		HDBaseT		
		Off		
	Network	IP Address		
		Subnet Mask		
		Gateway		
		DNS	On/Off	
		DHCP		
		Mac Address		
	Lens Setting	Lens Lock	Off	
			On	
		Lens Control	Zoom	
			Focus	
			Lens Shift	Shift V
				Shift H
		Lens Type	Non-UST Lens	
			UST Lens	
		Center Lens	Yes	
			No	
		Lens Memory	Memory 1-10	

Main Menu	Submenu	
	Keystone	H Keystone V Keystone
	Corner Adjustment	Top Left Corner Top Right Corner Bottom Left Corner Bottom Right Corner
	Advanced	RS-232
		Baud Rate
		38400 19200 9600
		Chanel
		Local HDBaseT
		Auto Power Off Auto Power On Message Box Screen Format
		16:10 16:9 4:3
		Screen Shift
		16:10 16:9 4:3
		H/V Alignment
		H Zoom V Zoom H Shift V Shift Reset
		Anti-Dust Shutter
		Off On
SERVICE	Model	
	Serial Number	
	Software Version	
	Lamp Status	Lamp1 Status Lamp2 Status
	Source Information	Active Source
		Active Source
		Pixel Clock Signal Format H/V Refresh Rate Sync Type Sync Polarity Scan Type Video Type
	Usage Time	Lamp1 Life Remaining Lamp2 Life Remaining Lamp1 Time Lamp 2 Time Power On Time
	Filter Timer Reset	
	Factory Reset	

OSD Operation - PICTURE

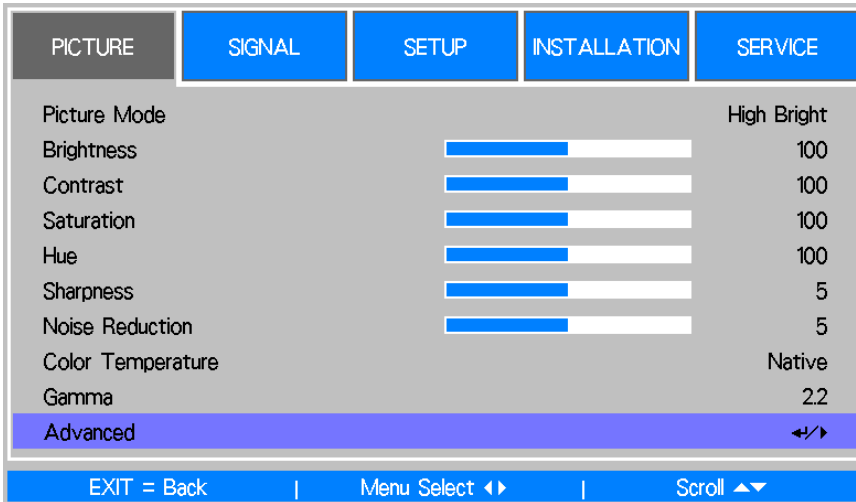

Picture Mode

Use ◀ or ▶ to select a set of preset picture mode

High Bright: The highest brightness output mode is suitable for the occasion where high brightness is needed.

Presentation: The best image effect is suitable for the presentation or picture.

Video: The best color mode is suitable for play of the video.

Brightness

Use ◀ or ▶ to increase or decrease the brightness of the image.

Contrast

Use ◀▶ to adjust the contrast of the projected image.

Saturation

Use ◀▶ to adjust the saturation level of the color (the higher the level, the higher the saturation).

Hue

Use ◀▶ to adjust the level of hue for reproduction of the true color.

Main Color	Hue		
R	Magenta	↔	Yellow
G	Yellow	↔	Cyan
B	Cyan	↔	Magenta
C	Green	↔	Blue
M	Blue	↔	Red
Y	Red	↔	Green

Sharpness

Use ◀▶ to adjust the sharpness. The purpose of this adjustment is to change the value of the high-frequency detail.

Noise Reduction

Use ◀▶ to adjust the noise of the projected image. This function is suitable for removing the noise of the image in interlaced scanning input. Generally, noise reduction can lower the value of the high-frequency detail and make the image softer.

Color Temperature

Use ◀▶ to adjust the color temp of the projected image, the option can be 5400K, 6500K, 7500K, 9300K and Native.

Gamma

When the ambient light is too bright and may affect the display of the details in the darker area of the image, you can select from the following gamma options to adjust the chrominance of the image, the selectable options are 1.0, 1.8, 2.0, 2.2, 2.35, 2.5, S-Curve.

Advanced

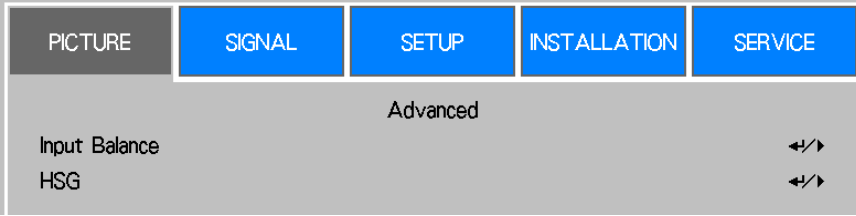

Input Balance

There are two options to fine tune Red, Green and Blue color

Offset: These three options will shift the color spectrum for the whole image and change its brightness, if minimal amount of red, green or blue appears in the gray areas, you can adjust the offset of the corresponding color accordingly. By increasing the offset, the image brightness will become lower.

Gain: These three options are used to increase or decrease the range of color input for the entire image. If minimal amount of red, green or blue appears in the gray areas, lower the gain of the corresponding color accordingly. As gain increases, the contrast of the image will become lower.

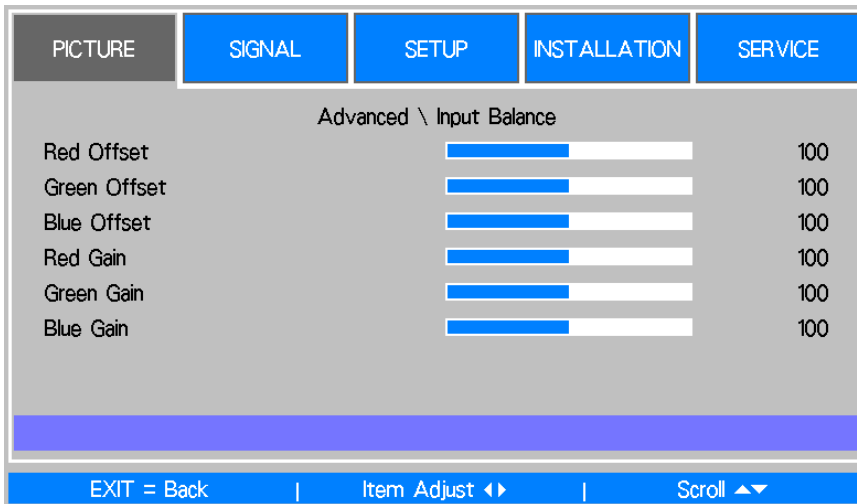

HSG

HSG is a function to adjust Hue, Saturation and Gain independently, it allows for specified color adjustments that are more intuitive. You can adjust Hue, Saturation and Gain for Red, Green, Blue, Cyan, Magenta, Yellow and white independently.

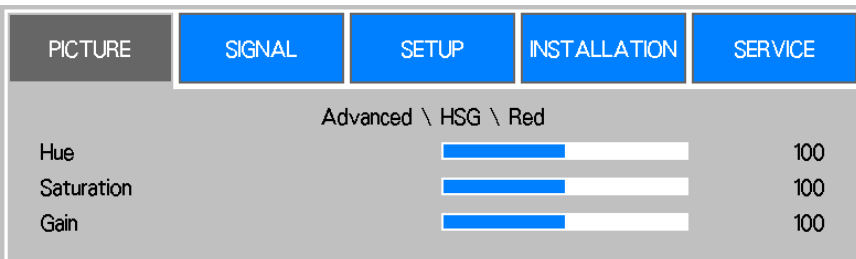

OSD Operation - SIGNAL



Input Selection

This function is same as the shortcut key on the remote control. You can use the remote control or this function to select the correct input source.

HDMI I

Select input source from HDIMI output of the computer or media device to HDMI I

HDMI II

Select input source from HDIMI output of the computer or media device to HDMI I

DVI-D

Select input source from DVI-D output of the computer or media device.

VGA

Select input source to VGA.

Component / BNC

Select Input source from BNC, the input source can be RGBHV or Component signal from computer or component video enabled device.

HDBaseT

HDBaseT input source from the HDBaseT transmitter.

EDID Mode

Sometime the projector may not display the desired timing due to the compatibility of the device; you can use this function to select the desired timing for projection. The preferred timings are listed by input source, you can use ▲ or ▼ button to select preferred timing for projection or select the timing automatically by setting it to Default.

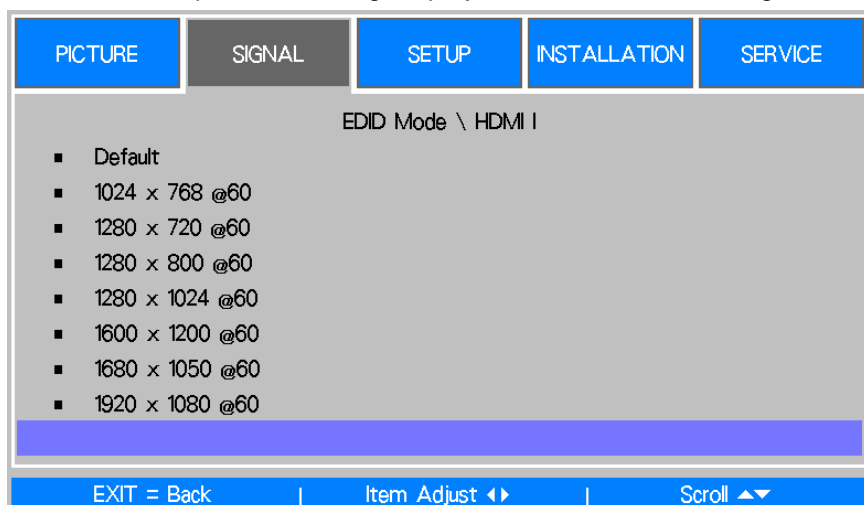

Auto Search

Use the ◀▶ function to turn on/off Auto Search for the input source.

Color Space

This function allows you to change the corresponding color space for the input signal. In most cases, the correct color space can be selected automatically by Auto mode. If the selection is not correct, you can use a specific color space forcibly by selecting one of the following options:

Auto: The projector detects the input signal and switches to the corresponding color space automatically.

YPbPr: Set the color space to ITU-R BT.601.

YCbCr: Set the color space to ITU-R BT.709.

RGB-PC: Use the RGB color space and set the black to 0, 0, 0 RGB while set the white to 255, 255, 255 RGB (if an 8-bit image is used).

RGB Video: Use the RGB color space and set the black to 16, 16, and 16 RGB while set the white to 235, 235, 235 (if an 8-bit image is used) to correspond to the luminance value defined in the digital component standard.

Aspect Ratio

This function allows the user to adjust the aspect ratio of the image.

Overscan

Noise may appear on the edge of the projected image, use this function to select Crop to hide the edge of the image or Off to display the original image.

Background

Use this function to specify the image to be displayed on the screen when no signal is input. You can select the Logo, Blue or Black.

Test Pattern

The built-in image is provided for installation and adjustment. You can select Test Pattern on OSD or the TEST PATTERN button on the remote control to display the test pattern menu, use ◀▶ or ▲▼ to select desired test pattern.

VGA Setup

Set the H Total, H Start, H Phase and V Start for the VGA signal display.

Auto Sync

You can use this function to set auto synchronization for the input signal.

Auto: The projector memorizes 10 sets of signal sources that you have used lately. When the Auto option is selected, the projector will choose the signal that you use last

Always: The auto sync function is executed every time.

OSD Operation - SETUP



Language

Select the familiar OSD Menu language. English, French, Spanish, Deutsch, Portuguese, Simplified Chinese, Traditional, Japanese and Korean.

Lamp Mode

Use the ◀▶ function to select the single-lamp or dual-lamp mode.

Dual: Enable the dual-lamp projection mode.

Single: Use the single-lamp mode for the projection. The lamp is not specified in this mode, the projector selects the lamp that has the least operation hours automatically whenever it is turned on

Lamp 1: Use Lamp 1 for projection. The system switches to Lamp 2 if Lamp 1 is abnormal in activation.

Lamp 2: Use Lamp 2 for projection. The system switches to Lamp 1 if Lamp 2 is abnormal in activation.



- In the Lamp 1 or Lamp 2 mode, the projector will switch to another lamp when the set lamp becomes abnormal. The corresponding LED indicator of the lamp will flash simultaneously for seconds and light up.
- When the lamp mode is set to Single, the setting will become valid upon turn-on of the projector next time.
- Quick switch of the lamp mode may affect the life of the lamp. The projector will disable the lamp mode function (highlighted) every time when a switch is conducted till the switch of the lamp mode is completed. The lamp mode options are not available before the switch of the lamp mode is completed receiver via control key button or RS-232 command.

Lamp Power

Use the ◀▶ function to select Normal, Eco or Custom Power Level mode.

Normal: Projection is carried out using the normal lamp power to obtain the brightest projection display.

Eco: Projection is carried out in the energy saving mode to ensure the longest service life of the lamp.

Custom Power Level: In addition to the Normal and Eco modes, the lamp power equal to 100% to 75% of the power in the Normal mode is used for fine-tune of the brightness in the Custom Power Level mode. This function can be used for quick installation and routine maintenance in multi-projector applications. Select this mode to enable the Custom Power Level function.

Custom Power Level

Select this function and use the ◀▶ to adjust lamp power between 100% and 75%, note that this function is valid only when Lamp Power is set to Custom Power Level.

Startup Logo

Use the ◀▶ function to turn on/off the Startup Logo.

Digital Alignment

Select this function to enlarge the projected image.

Digital Zoom: Use ◀▶ to enlarge the projected image.

Digital Pan: Use ◀▶ to move the projected image horizontally. This function is only available when the projected image is enlarged.

Digital Scan: Use ◀▶ to move the projected image vertically. This function is only available when the projected image is enlarged.

Reset: Set the Digital Alignment back to the factory default value.

Trigger

The projector is provided with a set of trigger output. User can connect the trigger to the screen with projector by the cable. If user does so, once the projector is powered, the screen would be automatically turned on as well. There is a 2-3 second delay to activate this function.

Dynamic Black

This is function can be used to enhance the black level of the projected image, set it to on to active the dynamic black shutter, otherwise, set it to off to disable it.

3D

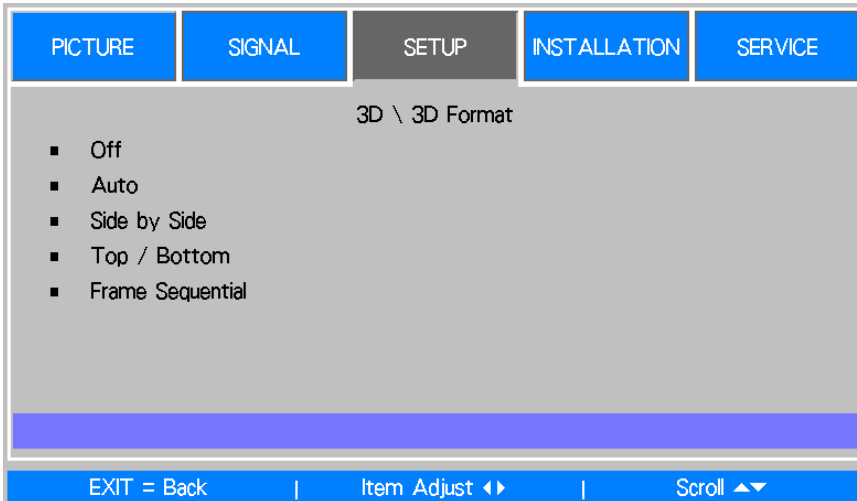

3D Format:

Select this option and press the Enter button to enable 3D replay and set 3D option.

Off: Turn off the 3D Display Mode. When Auto, Side by Side, Top/Bottom or Frame Sequential is selected, the 3D mode will be turned on. To turn off the 3D Mode, select "Off" and press the Enter button.

Auto: Enable the 3D format to automatically detect the formats of Side by Side, Top/Bottom and Frame Sequential. This function may only be enabled for the input signal below

- The input signal is HDMI 1.4 3D.
- The HDMI 1.4 3D signal connects to the projector through HDBaseT transmitter.

Side by Side: Manually switch the 3D Format to Side by Side. This option is only applicable to the HDMI input signal or the HDMI signal sent using HDBaseT transmitter

Top/Bottom: Manually switch the 3D Format to Top/Bottom. This option is only applicable to the HDMI input signal or the aforementioned signal sent through the HDBaseT transmitter.

Frame Sequential: Set the format to Frame Sequential.

DLP Link: Set to activate or deactivate the DLP Link sync signal.

Eye Swap: If the 3D imaged viewed through the 3D glasses for the left and right eyes are inverse, set the Eye Swap to "Reverse". If the images are normal, keep the current.

3D 24Hz Display: Set the 3D 24Hz image frame rate to 144fps or 96fps, this option is only applicable when the input signal is 24Hz.

Sync Reference: The projector provides DLP Link and 3D IR sync for 3D display; you can specify the built-in DLP Link or external 3D IR transmitter to synchronize the signal of the 3D glasses. This function is only applied to the condition that 3D Format is Frame Sequential or external 3D sync device is connected to the projector.

External: Signal is sent from external 3D sync signal receiver.

Internal: Signal is sent by the projector, 3D sync signal is DLP Link.

Sync Delay: Manually switch the Dark time for glasses tolerance.



- The projector provides DLP Link and 3D IR sync. After the 3D Mode is enabled, the built-in DLP Link or external 3D IR transmitter can be used to synchronize the signal of the 3D glasses. Or, you may turn off the DLP Link sync signal and only select the external 3D IR transmitter to synchronize the 3D signal.



Caution

The people listed below shall be aware when watching 3D images:

- Children under six years in age.
- People who are allergic to light, unhealthy and have the history of cardiovascular.
- People who are tired or lack of sleep.
- People who are under the impact of drug or alcohol.
- Normally, it's safe to watch 3D images. However, some people might feel uncomfortable. Refer to the guidelines revised and released by the 3D League on December 10, 2008.
- People need to take a break for at least 5 to 15 minutes every thirty minutes or one hour.

Advance

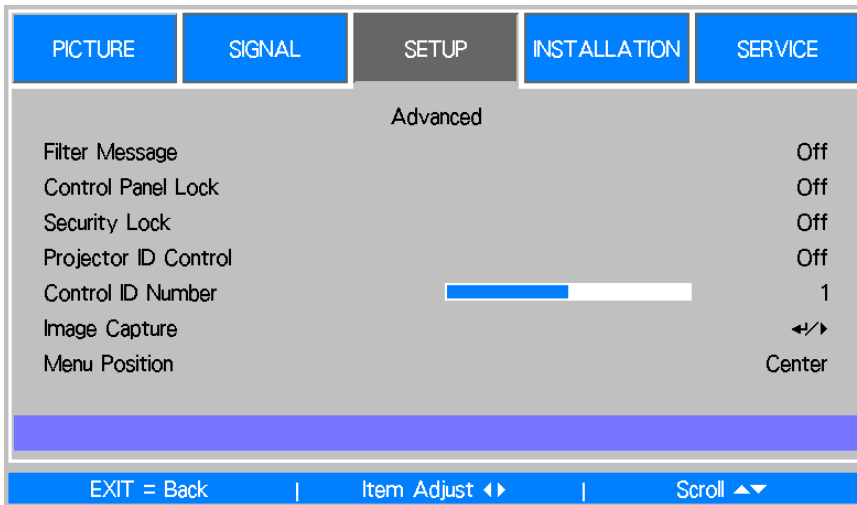

Filter Message

This function allows you to set interval time to display a reminder for cleaning the filter; the available options are Off, 100H, 200H, 500H and 1000H. Please make sure to reset the filter Message after cleaning the filter.

Control Panel Lock

This function allows you to lock control panel on the projector. Set it to On to lock the control panel, otherwise, set it to Off to unlock the control panel. Refer to page 25 for the details.

Security Lock

The projector has a built-in security feature to lock the OSD control panels and deny remote control operation for preventing the unauthorized use of the Projector. To lock the projector, please select the option to On and define a password followed the pop up window. Refer to page 25 for the details.

Projector ID Control

This option allows you to enable the projector ID control function. You can turn on this function and give an ID number for the projector, then set the same ID number for the remote control to match the projector ID. After ID code is set, you can control the specified projector by the remote control.

Control ID Number

Select the option then press ◀ or ▶ to set the ID number of the projector, this option is selectable when Projector ID Control is enabled.

Menu Position

Adjust menu position through this function, the available position options as below.

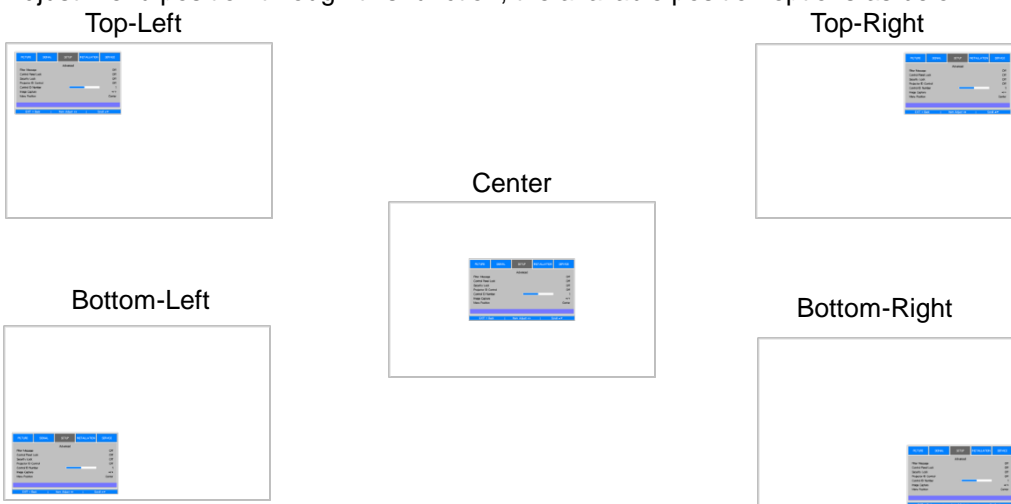

OSD Operation - INSTALLATION

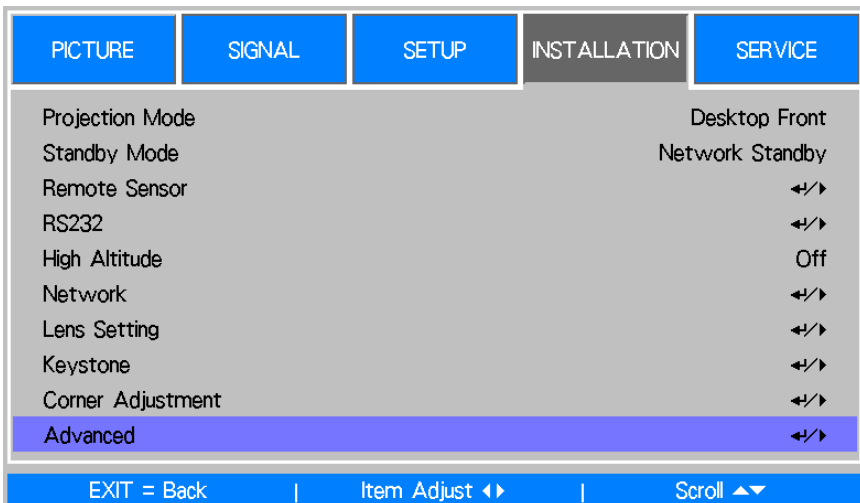

Projection Mode

Use the ◀or▶ function to select a projection mode to flip the projected image as installation orientation or viewing direction. The selectable options are as below.

- Desktop Front:** Install the projector on the desktop and project the image forward.
- Desktop Rear:** Install the projector on the desktop and project the image from the rear of the screen.
- Ceiling Front:** Mount the projector on the ceiling and project the image forward.
- Ceiling Rear:** Mount the projector on the ceiling and project the image from the rear of the screen.

Cooling Condition

The projector is with high precise optics components and lamp for high performance, these components needs properly to be cooled by air flow. The projector orientation may affect the air through the components, please select the corresponding cooling condition as installation orientation.

- Table:** Install the projector on the table and project the image within 60 degree.
- Ceiling:** Mount the projection on the ceiling and project the image within 60 degree.
- Upward:** Project the image upward or the installation angle the angle is over 60 degree.
- Downward:** Project the image downward or the installation angle the angle is over 60 degree.

Refer to Setting up the Cooling Condition on page 19.



- Incorrect Cooling Condition setting may affect hot air exhausting from the projector, the heat and high temperature may cause the projector to enter system protection or damage component. Please make sure the setting can match with the installation condition.

High Altitude

Use this function to control the cooling fan of the projector, the default setting is OFF. Normally, the projector can operate normally when this function is set to OFF. If the projector is installed in high altitude area, the cooling fan needs to be regulated to higher fan speed for well cooling. In this case, please enable this function by setting it to ON and have the cooling fans operate at a higher speed to obtain enough air flow for cooling.

Standby Mode

Use the ◀or▶ to set up Standby Mode.

- Network Standby:** The projector maintains in the standby status at higher power (<3W) for network control. In this mode, the projector can be turned on via network control system.
- Eco:** The projector maintains in the standby status at the lowest power (<0.5W), the projector can be turned on using the remote control, RS-232 command.

Remote Sensor

This function allows you to setup the IR control signal receiving from which receiver of the projector.

- Front / rear:** Both front IR and rear IR receiver are turned on.
- Front:** Turn on front IR receiver only; rear IR receiver is turned off.

Rear: Turn on rear IR receiver only; front IR receiver is turned off.

HDBaseT: Select HDBaseT input for IR control signal transmitting if the optional HDBaseT transmitter is capable of IR signal receiving and transmitting. Both front IR receiver and back IR receiver are turned off if the option is selected.

Off: Turn off all of receivers.

- All of IR signal receiving is disabled when the option is selected to Off, the projector can be operated by control buttons on the projector and RS-232 command only.

Network

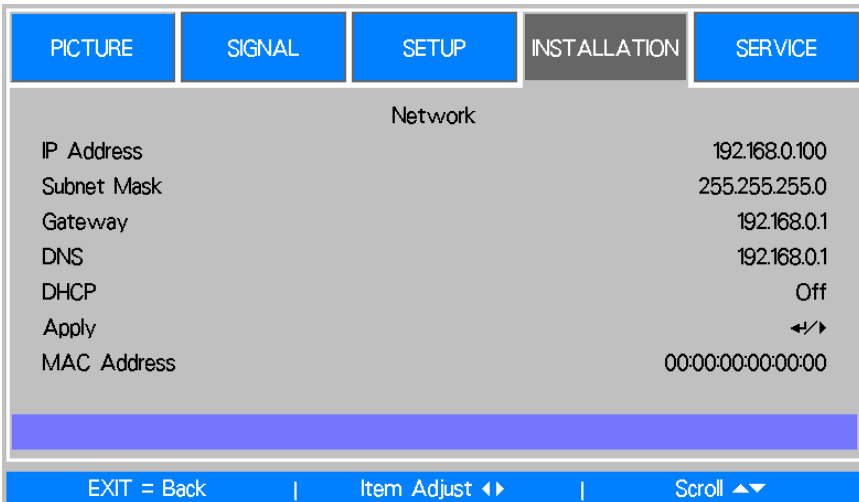

Use this function to set up network configurations so that you can control the projector via the network. Press **▲** or **▶** and Enter button to select the option:

IP Address: To specify an IP address.

Press the Enter button to show the IP address input window, use the **◀** or **▶** button to select the number in the address to be changed, **▲** or **▼** button to increase or decrease the number in the IP address.

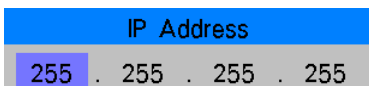

Subnet: Set the subnet, the input method is same as the IP address.

Gateway: Set the gateway, the input method is same as the IP address.

DNS: Set the DNS, the input method is same as the IP address

DHCP: Set DHCP to ON/OFF. When DHCP is set to ON, the DHCP server of the domain will assign an IP address to the projector. The IP address will appear in the IP address window and you don't need to make any input. Otherwise, the domain does not or cannot assign any IP address, and 0. 0. 0. 0 is shown on the IP address window.

Apply: Select this button and press Enter. It takes the projector several seconds to execute the change of the network setting till the following message disappears.

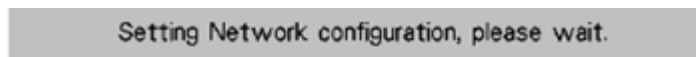

MAC Address: Display Mac address of the projector.

For more information about the network control connection and setting, refer to Remote Communication Guide

- Any change you made is restored in the projector after Apply option is confirmed.

Lens Setting

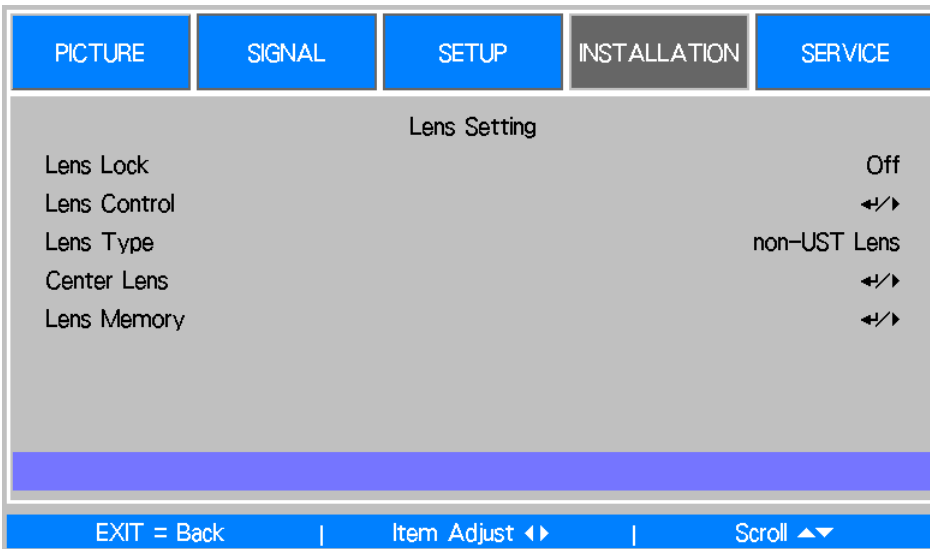

Lens Lock

This function can be used to disable lens control for preventing unauthorized operation or disoperation in lens control related functions including Lens Shift, Zoom/Focus adjustment and Center Lens. Recommend to turn on Lens Lock function to disable the Lens control after lens adjustment is done



- Turning on Lens Lock will disable lens control function including Lens Shift, Center Lens and Zoom/Focus adjustment, please make sure Lens Lock is disable before you perform the lens control function.

Lens Control

Select this function to display Lens Control menu for adjustment of Zoom, Focus, or Shift. You can use the ENTER button to switch the Zoom / Focus or Shift menu. Use ▲or▼ to adjust zoom and vertical shift of the lens, or use ◀ ▶ to adjust focus and horizontal shift of the lens.

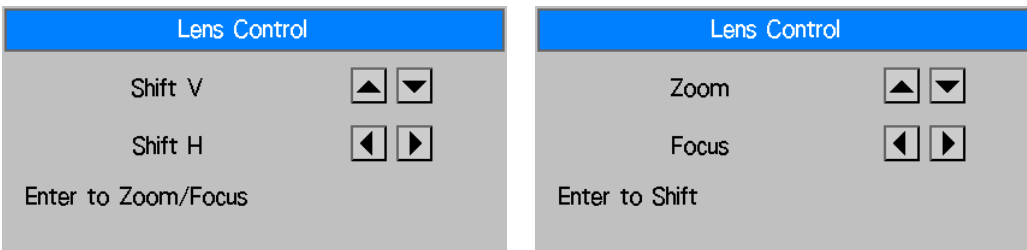

Lens Type

There are eight projection lenses can be used in DU6771; the initial projection position of Ultra Short Throw (UST) Lens is different to other seven projection lenses. The projector preset two initial projection positions for Ultra Short Throw lens and the others accordingly, Center Lens function can moves the lens to the initial position (center) automatically according Lens Type setting. Please set this option to UST Lens if Ultra Short Throw Lens is installed in the projector, otherwise please set it to Non-UST Lens.



- There are two default positions, one is for regular zoom or fixed focus lens (Non-UST), the reference position is 0% of image width in horizontal shift and 0% of the image height in vertical shift; another one is for Ultra Short Throw Lens (UST), the default position is around 0% of image width in horizontal shift and 56% of image height in vertical shift. When performing Center Lens functions, projector will move the lens to the default position according to Lens Type setting.
- If Ultra Short Throw Lens is installed and UST Lens is selected, you can perform Center Lens to move Lens to initial projection position automatically.
- If using Ultra Short Throw Lens and setting to Non-UST Lens, the lens will be moved to the position which is lower than the default position of Ultra Short Throw Lens after performing Center Lens function, it causes the projected image is blocked by the top cover of the projector. In this case, please perform the Lens shift function to move up the Lens till the image can be projected normally.

- 
 • please make sure Lens Type setting is set to Non-UST Lens then perform Center Lens function if other zoom lens or fixed focus lens is used, or lens shift range is limited, center position of the lens is not correct.

Center Lens

This is the lens calibration function, the projector calibrates the lens shift, focus and zoom parameters for the precise lens memory function. After performing this function, the lens will be moved to the corresponding center position by Lens Type setting.

- 
 • There are two default center positions for UST (Ultra Short Throw) Lens and non-UST Lens, make sure Lens Type setting is correct before performing this function.
- If Ultra Short Throw Lens is installed, make sure the support kit is detached before performing Center Lens.

Lens Memory

This projector supports Lens Memory function, Lens shift, Zoom and Focus memory can be stored in the projector up to 10 sets. You can load the stored memory setting to set up the lens automatically, and give a name for the memory set by keyboard simulator as below figure.

Load Memory: Use ▲ or ▼ to select the desired memory setting then press ENTER button to execute the lens setting, the projector will adjust the Lens position, Zoom and Focus automatically.

Save Memory: Use ▲ or ▼ to select the memory set for storing the setting then press ENTER button to confirm.

Clear Memory: Select the memory set to be cleared then press ENTER button to confirm clearing memory set.

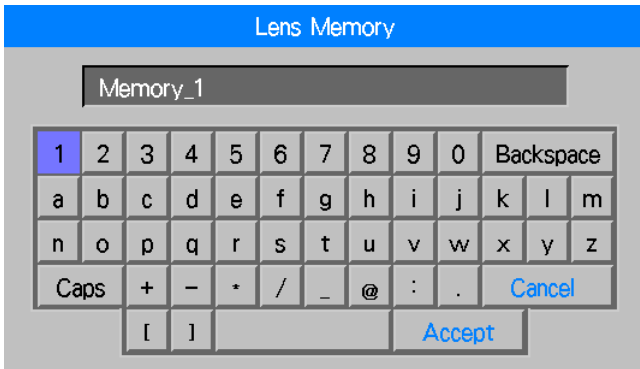

Keystone

When the image is projected toward the screen at angle, the image becomes distorted trapezoid; this function can be used to correct the distortion.

H Keystone: Use ◀▶ to correct the distortion in horizontal direction.

V Keystone: Use ▲▼ to correct the distortion in vertical direction.

Reset: Reset H and V keystone to default settings.

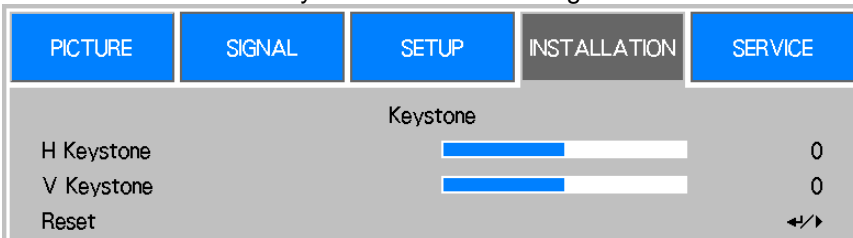

Refer to Correcting Keystone Distortion on page 21.

Corner Adjustment

Keystone adjust the four corners followed specified ratio at the same time, this function allows you to adjust the individual corner in horizontal or vertical direction as below illustration

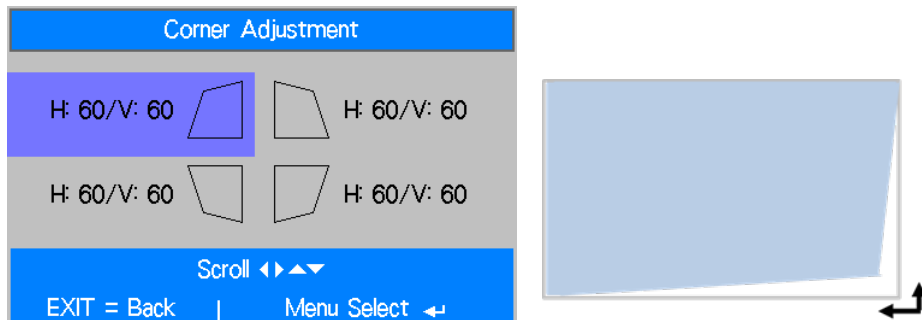

Refer to Correcting Distortion at the Corner on page 22.

Advance

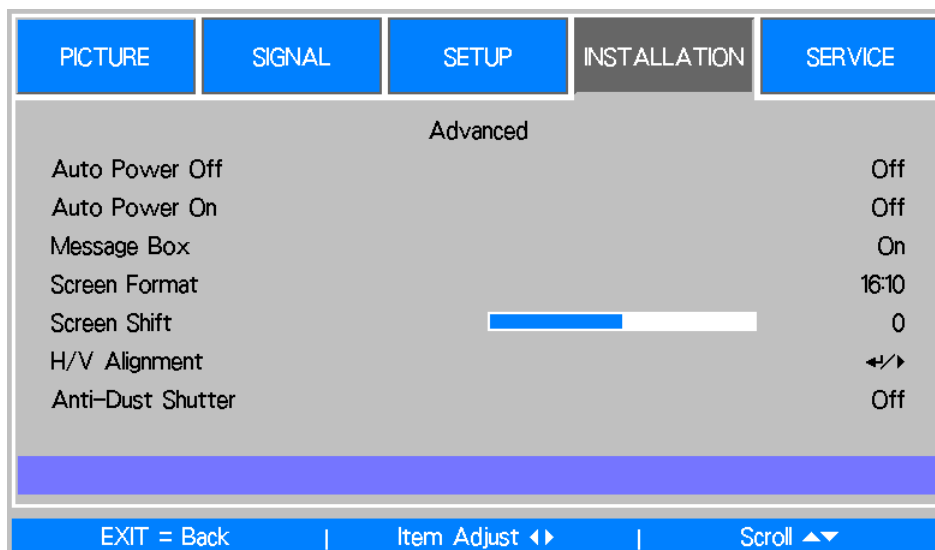

RS232

Baud Rate: Set the transmission rate to 38400, 19200, 9600. The setting of the transmission rate is dependent on the length of the RS-232 cable. Low transmission rate is usually set for which transmission distance is long; please select a suitable transmission rate.

Channel: The RS232 control command can be sent to the projector through its RS-232 port, the command can also be sent to the projector through the external HDBaseT transmitter to HDBaseT/LAN terminal of the projector. Set the following communication channels before sending the control command

Local: The RS-232 control command is sent through the RS-232 port on the projector. Select an appropriate transmission rate.

HDBaseT: Transmission is conducted from the external HDBaseT transmitter to the RJ-45 port on the projector. The transmission rate is switched to 9600.

Auto Power Off

This function is set to OFF by default. When it is set to ON and no input signal is received within 20 minutes, the projector will turn off automatically.

Auto Power On

This function is set to OFF by default. When it is set to ON, the projector will turn on automatically when y AC power is turned on next time. You can use this function and the power switch (instead of the remote control) to turn on the projector. Set this function to OFF if it's unnecessary.

Message Box

This function allows you to disable the pop-up message at bottom-right of the screen or any reminding message. Set this option off to disable the message on the screen except of OSD menu.

Screen Format

This function allow you to resize the projected image for fitting the projection screen, the selectable screen format is 16:10, 16:9, 4:3. The projected image is scaled down if the option is set to 16:9 or 4:3, the image can be moved a little bit for fitting screen by Screen Shift function.

Screen Shift

This function allows you to adjust projected image position if screen format is not set to native aspect ratio. For example, native aspect ratio of DU6771 is 16:10, the image can be moved up or down if Screen Format is set to 16:9; the projected image can be moved left or right if Screen Format is set to 4:3. The option can't be selected if screen format is set to native aspect ratio of the product.

H/V Alignment

H Zoom: Use ◀▶ to narrow the horizontal size of the projected image.

V Zoom: Use ◀▶ to narrow the vertical size of the projected image.

H Shift: Use ◀▶ to move the narrowed projected image horizontally. This function is only available when the projected image is narrowed.

V Shift: Use ◀▶ to move the narrowed projected image vertically. This function is only available when the projected image is narrowed.

Reset: Set the H/V Alignment back to the factory default value.

Auto-Dust Shutter

The product is equipped mechanical shutter, you can use mechanical shutter to stop the projection temporarily. Beside this function, you can enable the shutter for preventing the dust attached on the lens when the projection lens is removed. The shutter is closed in each power off operation and is opened when power is turned on if the option is set to On.



- Recommend to set this option to off when the projector is installed or the projection lens is installed in the projector, use this function when the lens is removed.

OSD Operation - SERVICE



Model

Display the project model name.

Serial Number

Display the serial number of the projector.

Software Version

Display the software version in the projector.

Control/Remote ID

Display current projector ID and remote control ID

Lamp Status

Display current Lamp 1 and Lamp 2 status.

Source Information

Display the current input source information.

Usage Time

Display current projector time of the projector

Lamp Life Remaining: Display estimated remaining lamp life.

Lamp1 Time: Display current lamp usage.

Filter Time: Display the time from last reset of filter timer to now.

Power On Time: Display the total Power-On time of the projector.

Signal Format

Display current input source format

H/V Refresh Rate

Display horizontal and vertical refresh rate of the current picture.

Pixel Clock

Display pixel clock of the current input signal.

Light Time

Display accumulated usage of projection light source

Thermal Status

Display current status of the thermal management components.

Factory Reset

The user can use this function to reset all the settings to factory default.

Product Specification

Model	DU6771	
Display Type	Single Chip 0.67" DLP Technology	
Brightness	6,500 ANSI Lumens	
Native Resolution	WUXGA (1920 x 1200)	
Maximum Resolution	WUXGA (1920 x 1200)@60Hz (Reduced Blanking)	
Contrast Ratio	3000:1	
Lamp Type and Life ^{*1}	UHP 300W, 3000/4000 hours (Normal/ECO)	
Throw Ratio ¹	1.73 - 2.27:1	
Image Size (Diagonal) ^{*2}	40" - 500"	
Projection Distance ^{*2}	1.45 - 24.85m (4.77ft to 81.52ft)	
Projection Lens ^{*2}	F = 1.7 - 1.9, f = 26 - 34mm	
Zoom Ratio ^{*2}	1.3x	
Aspect Ratio	16:10	
Lens Control	Motorized lens control	
Horizontal Frequency	15, 30 – 90Hz	
Vertical Scan Rate	50 - 85Hz	
Keystone Correction	Horizontal ±30°, Vertical ±30° (individual adjustable range)	
Corner Adjustment	60 pixels in horizontal or vertical direction.	
3D Functionality	Yes (DLP® Link™, HDMI v1.4 (Blu-ray, side by side, frame packing, top and bottom))	
Adjustable Lens Shift Range ^{*3}	Vertical: -33% to +64%, Horizontal: -14% to 24%	
I/O Connection Ports	HDMI v1.4a (x2) DVI-D, Component (5 BNC), VGA-In, VGA-Out, HDBaseT™/LAN (Shared), 3D-Sync In/Out, 12v Trigger, RS-232, Wired Remote, USB for service.	
Projection Method	Table Top, Ceiling Mount (Front or Rear), Upward and Downward	
Security Solutions	Kensington® Security Slot, Security Bar, Anti-Theft Lens Screw, Security Lock and Control Panel Lock features.	
Dimensions (WxDxH)	510 x 470 x 210mm (20.1" x 18.5" x 8.3")	
Weight	20Kg (44.1lbs)	
Noise Level	35 dB (Normal Mode, Desktop Installation)	
Power Supply	100-240V AC, 50/60Hz	
Power Consumption	Normal Dual Lamp Mode,	735W @100Vac, 690W @240Vac
	Network Standby	Less 3W
	Eco Standby	Less 0.5W
Operation Condition	At temperature 0 to 40° C, relative humidity 10% to 85%,non-condensation	
Storage Condition	At temperature -10 to 60 °C , relative humidity 5% to 95%,non-condensation	
Standard Accessories	AC Power Cord, Remote Control w/Batteries, Lens Cap, Anti-Theft Lens Screw, Documentation Kit	
Optional Accessories	Interchangeable Lens Options, Color-type color wheel module	

Note:

*1: Lamp life may differ from lamp to lamp, installation conditions and the environment of use, the lamp life listed here is referred to testing in manufacturer's laboratory, and the projector is desktop and ceiling installation. Brightness decay in upward or downward installation is faster than desktop or ceiling installation. Refer to laboratory test results, Lamp life may be reduced to 50-75% of the life which the projector is installed by Desktop or Ceiling installation

*2: Standard Lens

*3: This is adjustable lens shift range of the projector, the best preference range of the projection lens may be different, please refer to projections lens specification

©2016 Vivitek. Vivitek is a trademark of Delta Electronics, Inc. Other trademarks are the properties of their respective owners. Values, weights and dimensions shown are approximate. Errors and omissions accepted. Specifications are subject to change without prior notice.

Supported Signal Input Timing

Signal Format	Resolution	Frame Rate (HZ)	VGA, BNC		HDMI / HDBaseT			DVI-D	
			SOG	RGBHV	RGB	YUV			
						8-bit	10-bit		12-bit
PC	640x480	59.93		O	O				O
	640x480	75		O	O				O
	640x480	85.01		O	O				O
	800x600	60.32		O	O				O
	800x600	75		O	O				O
	800x600	85.06		O	O				O
	848x480	60		O	O				O
	1024x768	60		O	O				O
	1024x768	75.03		O	O				O
	1024x768	85.03		O	O				O
	1024x768	120		O	O				O
	1024x768RB	119.98		O	O				O
	1280x720	59.91		O	O				O
	1280x720	120		O	O				O
	1280 x 768	60		O	O				O
	1280 x 800	60		O	O				O
	1280x800RB	119.9		O	O				O
	1280 x 960	60		O	O				O
	1280x1024	60.02		O	O				O
	1280x1024	75.02		O	O				O
	1280x1024	85.02		O	O				O
	1366 x 768	60		O	O				O
	1440 x 900	60		O	O				O
1400X1050	60		O	O				O	
1600x1200	60		O	O				O	
1680x1050	59.94		O	O				O	
1920x1200RB	60		O	O				O	
SDTV	480i	59.94	O	O					
	1440x480i	60			O	O	O	O	
	1440x576i	50			O	O	O	O	
	576i	50	O	O					
EDTV	480p	59.94	O	O	O	O	O	O	O
	576p	50	O	O	O	O	O	O	O
HDTV	1080i	50	O	O	O	O	O	O	O
	1080i	59.94	O	O	O	O	O	O	O
	1080i	60	O	O	O	O	O	O	O
	720p	50	O	O	O	O	O	O	O
	720p	59.94	O	O	O	O	O	O	O
	720p	60	O	O	O	O	O	O	O
	1080p	23.98	O	O	O	O	O	O	O

Signal Format	Resolution	Frame Rate (HZ)	VGA, BNC		HDMI / HDBaseT			DVI-D	
			SOG	RGBHV	RGB	YUV			
						8-bit	10-bit		12-bit
1080p		24	O	O	O	O	O	O	
1080p		25	O	O	O	O	O	O	
1080p		29.97	O	O	O	O	O	O	
1080p		30	O	O	O	O	O	O	
1080p		50	O	O	O	O	O	O	
1080p		59.94	O	O	O	O	O	O	
1080p		60	O	O	O	O	O	O	

Supported 3D Signal

3D Format		Resolution	V-Freq (Hz)	V-Total	H-Freq (kHz)	HDMI I, HDMI II
720p50	Frame Packing	1280x720	50.00	1470	37.50	O
720p59	Frame Packing	1280x720	59.94	1470	44.96	O
720p60	Frame Packing	1280x720	60.00	1470	45.00	O
720p50	Top-and-Bottom	1280x720	50.00	750	37.50	O
720p59	Top-and-Bottom	1280x720	59.94	750	44.96	O
720p60	Top-and-Bottom	1280x720	60.00	750	45.00	O
1080p23	Frame Packing	1920x1080	23.98	2205	26.97	O
1080p24	Frame Packing	1920x1080	24.00	2205	27.00	O
1080i50	Side-by-Side (Half)	1920x1080	50.00	1125	56.25	O
1080i59	Side-by-Side (Half)	1920x1080	59.94	1125	67.43	O
1080i60	Side-by-Side (Half)	1920x1080	60.00	1125	67.50	O
1080p50	Side-by-Side (Half)	1920x1080	50.00	1125	56.25	O
1080p59	Side-by-Side (Half)	1920x1080	59.94	1125	67.43	O
1080p60	Side-by-Side (Half)	1920x1080	60.00	1125	67.50	O
1080p50	Top-and-Bottom	1920x1080	50.00	1125	56.25	O
1080p59	Top-and-Bottom	1920x1080	59.94	1125	67.43	O
1080p60	Top-and-Bottom	1920x1080	60.00	1125	67.50	O
1080p50	Frame Sequential	1920x1080	50.00	1125	56.25	O
1080p59	Frame Sequential	1920x1080	59.94	1125	67.43	O
1080p60	Frame Sequential	1920x1080	60.00	1125	67.50	O

*3D Glasses Refreshing Rate: 96/100/120Hz

*3D Sync signal: DLP Link, IR

Configurations of Terminals

DVI-D Terminal

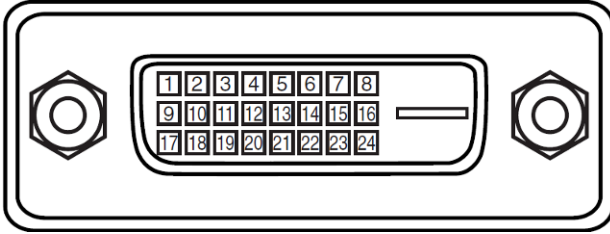

1	T.M.D.S. Data 2- Input	13	N.C
2	T.M.D.S. Data 2+ Input	14	P5V
3	Ground	15	Ground
4	N.C	16	HPD
5	N.C	17	T.M.D.S. Data 0- Input
6	SCL	18	T.M.D.S. Data 0+ Input
7	SDA	19	Ground
8	N.C	20	N.C
9	T.M.D.S. Data 1- Input	21	N.C
10	T.M.D.S. Data 1+ Input	22	Ground
11	Ground	23	T.M.D.S. Clock+ Input
12	N.C	24	T.M.D.S. Clock- Input

VGA Terminal (D-sub 15 pin)

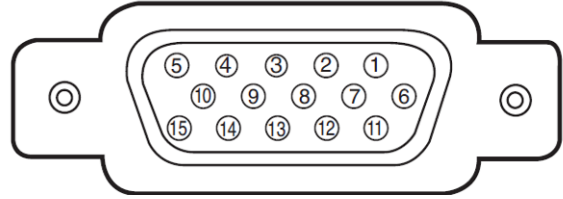

Input

1	Red Input	9	P5V
2	Green Input	10	GND
3	Blue Input	11	GND
4	N.C	12	VGA_SDA
5	N.C	13	H-Sync
6	GND	14	V-Sync
7	GND	15	VGA_SCL
8	GND	16	GND

HDMI(19 pin Type A)

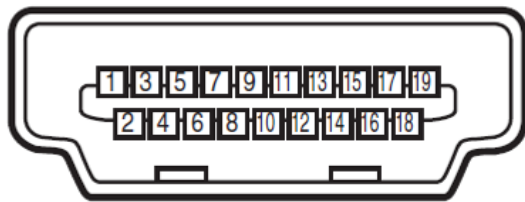

1	T.M.D.S. Data 2+ Input	11	Ground
2	Ground	12	T.M.D.S. Clock C- Input
3	T.M.D.S. Data 2- Input	13	CEC
4	T.M.D.S. Data 1+ Input	14	N.C
5	Ground	15	SCL
6	T.M.D.S. Data 1- Input	16	SDA
7	T.M.D.S. Data 0+ Input	17	Ground
8	Ground	18	P5V
9	T.M.D.S. Data 0- Input	19	HPD
10	T.M.D.S. Clock C+ Input		

Serial Control Terminal (RS-232, D-sub 9 pin)

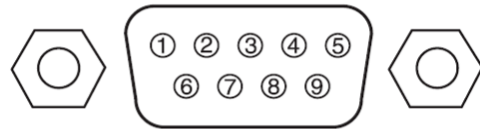

1	N.C
2	RXD
3	TXD
4	N.C
5	Ground
6	N.C
7	Short with pin8
8	Short with pin7
9	N.C

3D Sync Out

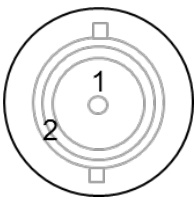

1	Signal
2	Ground

Service (USB Type B)

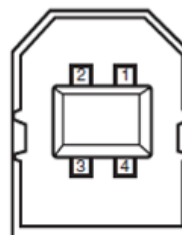

1	VCC
2	D-
3	D+
4	Ground

Screen Trigger

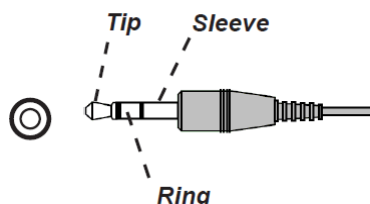

1	Tip	VCC(12V)
2	Sleeve-	Ground
3	Ring	Signal

Wired Remote

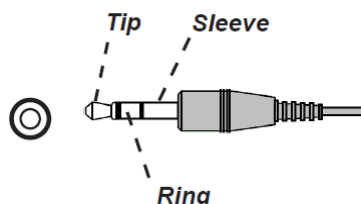

1	Tip	VCC(3.3V)
2	Sleeve-	Ground
3	Ring	Signal

HDBaseT/LAN Terminal (RJ-45)

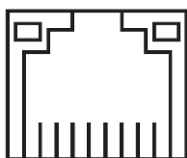

87654321

1	TX+
2	TX-
3	TXC
4	Ground
5	Ground
6	RXC
7	RX+
8	RX-

DU6771 Lens Series

Eight types of optional electric lenses are available for the projector as below table. Contact the authorized dealer of Vivitek for details.

Part Number	Lens Name	F Number	Focal Length	Zoom Ratio	Screen Size	Throw Ratio
D88-UST01	Ultra Short Throw	2.0	5.64mm	---	100"-350"	0.377:1
D88-UWZ01	Ultra Wide Zoom	1.96-2.3	11.3-14.1mm	1.25:1	40"-500"	0.75-0.93:1
D88-WF18501	Wide Fix	1.85	11.6mm	---	40"-500"	0.76:1
D88-WZ01	Wide Zoom	1.85-2.5	18.7-26.5mm	1.41:1	40"-500"	1.25-1.79:1
D88-ST001	Standard Lens	1.7-1.9	26-34mm	1.3:1	40"-500"	1.73-2.27:1
D88-SMLZ01	Semi Long Zoom	1.86-2.48	32.9-54.2mm	1.65:1	40"-500"	2.22-3.67:1
D88-LOZ101	Long Zoom 1	1.85-2.41	52.8-79.1mm	1.5:1	40"-500"	3.58-5.38:1
D88-LOZ201	Long Zoom 2	1.85-2.48	78.5-121.9mm	1.55:1	40"-500"	5.31-8.26:1

- The best performance of above zoom lenses is within vertical shift 0-50%, horizontal shift $\pm 10\%$, the projector may support to wider adjustable shift range for flexibility in installation.
- D88-WF18501 and D88-UST01 are fixed lens, the vertical and horizontal shift range of the projection lenses are 0%, the corners of the projected image may appear shadows or distortion if lens is shifted horizontally or vertically.
- For best projection performance, support kits for D88-UST01 lens is required, please refer to the installation manual of D88-UST01 for the details.

Product Dimensions

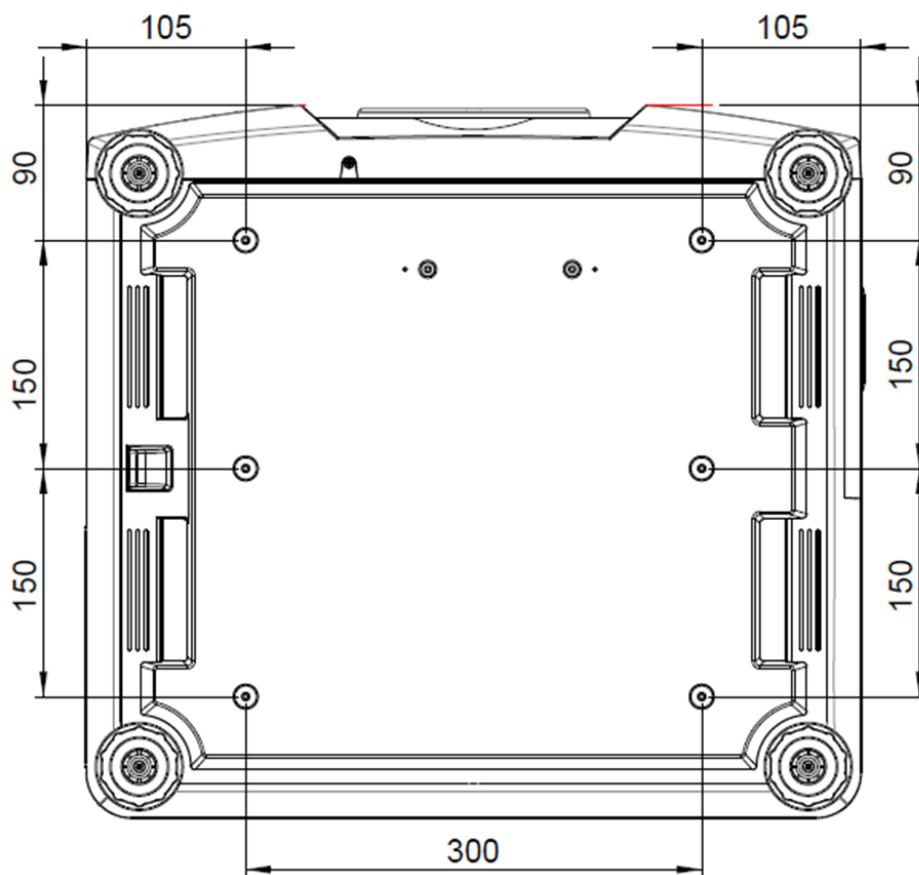
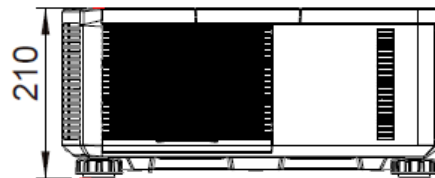
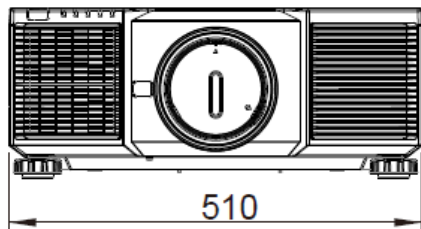
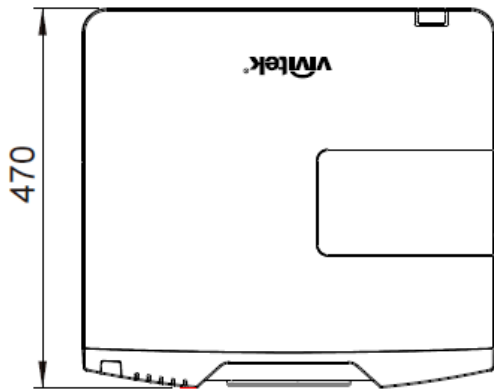

Replacing the Projection Lamps

Depending on the lamp model, the lamp life may be affected by the installation conditions and frequency of the lamp on/off operation. It is suggested to replace the projector lamp when the lamp is used for approximately 3000 hours to ensure high projection quality even the lamp can still work, please check the lamp usage from SERVICE Menu. Contact your local dealer to purchase the authorized new lamp suitable for your projector.

CAUTION



- Do not open any product enclosure and check the inside of the projector, inappropriate attempts to service the unit by anyone, especially those who are not appropriately trained to do so, may result in an accident or injury caused by pieces of broken glass or electric shock.
- Be sure to turn off the projector and AC power of the projector before replacing the lamp.



Lamp Handling Precautions:

- This projector uses a high-pressure lamp which must be handled carefully and properly. Improper handling may result in accidents, injury, or create a fire hazard.
- If the projector indicates that the lamp should be replaced, i.e., if LAMP1 or LAMP2 LED lights up, replace the lamp with a new one IMMEDIATELY after the projector has cooled down. Continuous use of the lamp with LAMP1 or LAMP2 LED lighted may increase the risk of lamp explosion.
- A Lamp may explode as a result of vibration, shock or degradation as a result of hours of use as its lifetime draws to an end. Risk of explosion may differ according to the environment or conditions in which the projector and lamp are being used. If a lamp explodes, please disconnect the projector's AC plug from the AC outlet immediately and contact an authorized service center or local dealer.
- Be sure to turn off and unplug the projector at least 30 minutes before replacing the lamp. Failure to do so could result in a severe burn.
- Safety glasses should be worn when replacing the lamp while the projector is mounting to the ceiling.



- Lamp life may differ from lamp to lamp and according to the environment of use. There is no guarantee of the same life for each lamp.
- Purchase the lamp module produced by Vivitek only. Using the lamp that is not made by Vivitek may affect the performance of the projector or damage the projector.
- Using the lamp over the lamp life limit may cause to lamp crack, please replace the new lamp even the lamp can still work.
- Recommend to regularly check the lamp and the brightness of projected image.
- Brightness decay of upward or downward installation is faster than desktop or ceiling installation if using regular lamp module. Refer to laboratory test results, Lamp life may be reduced to 50-75% of the life which the projector is installed by Desktop or Ceiling installation. Recommend to replace lamp module to specified part number for Upward or Downward installation, please consult the local dealer.

1. Turn off the projector and unplug the power cord. Wait till the projector, lamp and peripheral devices to cool off.

Turn off the power.

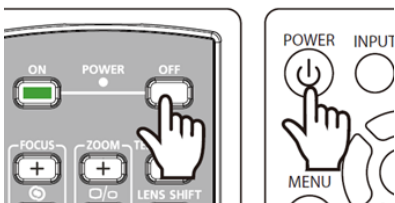

Switch off the AC power

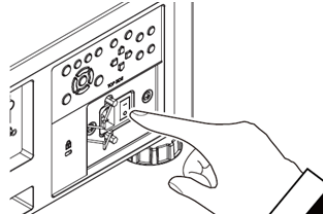

Unplug the power cable

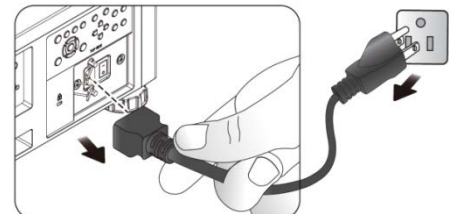

2. Loosen the screw on the lamp cover and take the lamp cover out as shown

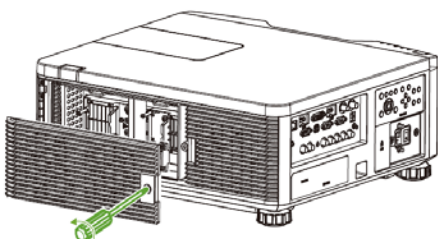

3. Loosen the three captive screws on the lamp module as below figure.

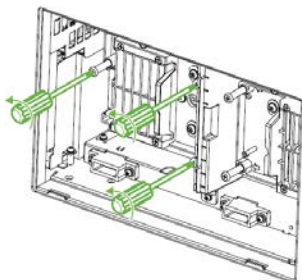

4. Take out the old lamp module, then install new lamp module as below figure.

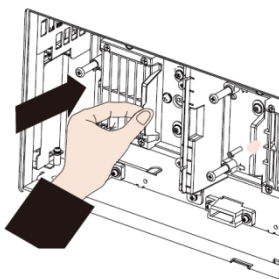
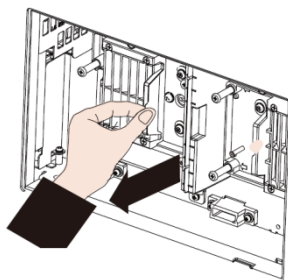

5. Tighten the three captive screws on the lamp module as below figure.

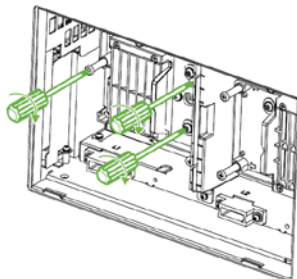

Follow the same procedure to change another lamp

6. Install the lamp cover and tighten the screw on it.

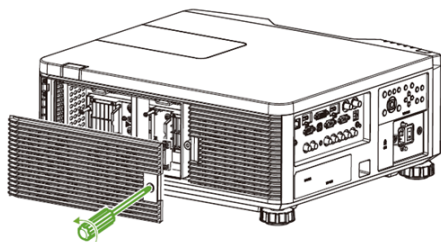

- After inserting the new lamp and tightening the 3 screws, please make sure the lamp is installed properly. Improper lamp installation may cause to system protection when projector is turned on. In this case, please double check if lamp is installed properly.

Replacing the Filter

The projector uses one high-density filter to keep the fans and lamp free of dust, other particles, and should be cleaned every 500 hours of operation. In dusty environments, it is recommended to clean the filters more frequently. If the filter is dirty or clogged, your projector may overheat and enter system protection status.

It recommends enabling Filter Message option on SETUP>Advanced, the projector can remind and display the message for the filter cleaning. After cleaning or replacing the filter, please reset the filter timer.

Note:

- Dirty filter may reduce the air flowing into the projector and the temperature in the projector may rise as a result. This may activate the protection mechanism or damage the components.
- Check, clean and replace the filter regularly.
- Dirty filter may reduce the air flowing into the projector and the temperature in the projector may rise as a result.

1. Turn off the projector and unplug the power cord. Wait till the projector, lamp and peripheral devices to cool off.

Turn off the power.

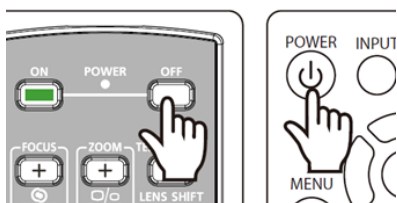

Switch off the AC power

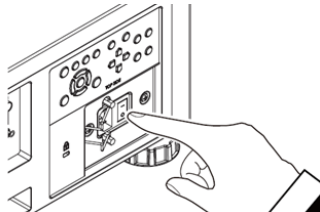

Unplug the power cable

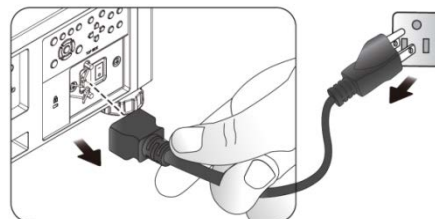

3. Loosen the screw on filter cover and remove the cover as below figure.

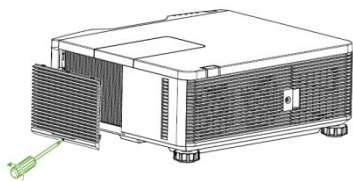

4. Take out the used filter from the compartment

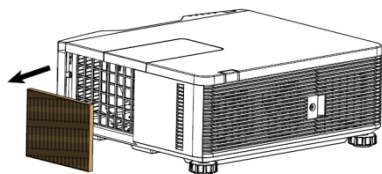

5. Use the brush and vacuum to clean the filter compartment, cover as below figure

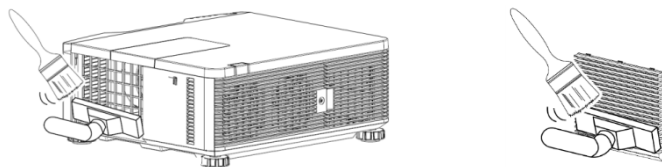

6. Install the new filter into the compartment.

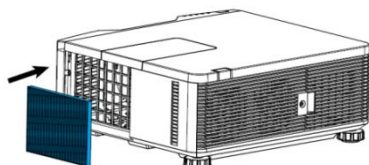

7. Install the filter cover and tighten the screw on it.

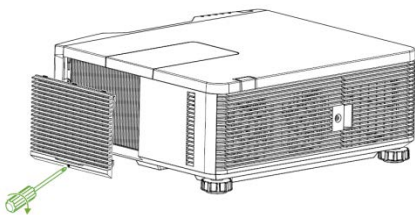

8. Turn on the projector and perform Filter Timer Reset to reset the usage on SERVICE page.

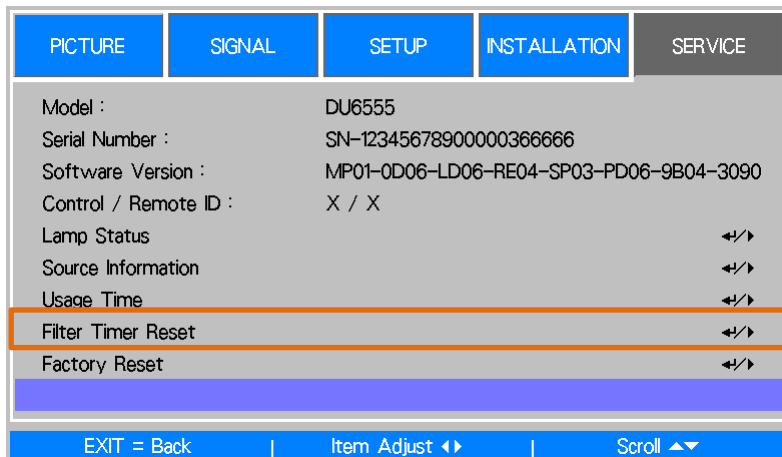

Cleaning the Projector

Cleaning the Cabinet

Refer to the following guide to clean the projector cabinet.

1. Wipe off dust with a clean dampened cloth.
2. Moisten the cloth with warm water and mild detergent and wipe the cabinet.
3. Rinse all detergent from the cloth and wipe the projector again.



- To prevent discoloration or fading of the case, do not use abrasive alcohol-based cleaners.

Cleaning the Lens

1. Apply a little optic lens cleaner to a clean, lint free cloth (do not apply the cleaner directly to the lens).
2. Lightly wipe the lens in a circular motion.



- Do not use abrasive cleaners or solvents.
- To prevent discoloration or fading, avoid getting cleaner on the projector case.

Troubleshooting

These guidelines provide tips to deal with problems you may encounter while using the projector. If the problem remains unsolved, contact your dealer for assistance.

Often the problem is something as simple as a loose connection. Check the following before proceeding to the problem-specific solutions.

Use some other electrical device to confirm that the electrical outlet is working.

- Ensure the projector is turned on.
- Ensure all connections are securely attached.
- Ensure the attached device is turned on.
- Ensure a connected PC is not in suspending mode.
- Ensure a connected notebook computer is configured for an external display. (This is usually done by pressing an Fn-key combination on the laptop.)

LED Indication

Several indicators messages are used to display the current projector status or alert the abnormal message.

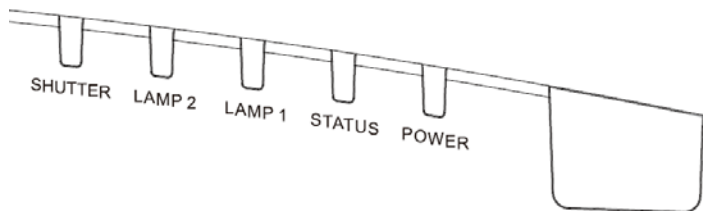

Power LED

LED Display		Projector status	Note
Off		AC Power is turned off	
Flashing	Green	Projector is turning on.	wait till projector start displaying
	Orange	Projector is under cooling	wait until cooling finish (~ 90 sec)
	Orange(one second)	Top covered is opened.	Checked if top cover is not installed properly.
On	Orange	Network standby mode	Projector enters to Network standby model(<3W)
	Red	Standby mode	Projector enters to ECO standby model(<0.5W)
	Green	Projector is on	

Status LED

LED Display		Projector status	Procedure
Off		Normal status	
Flashing	Red (1 time in one cycle)	Cover is opened.	Check if the top cabinet is installed properly.
	Red (2 times in one cycle)	Over temperature warning	Check if any object is placed near the vents or operation temperature is too high.
	Red (3 times in one cycle)	System error	Contact with your nearest authorized dealer or service center.
	Red (4 times in one cycle)	Cooling fan error	Contact with your nearest authorized dealer or service center.
On	Red	System Error	Contact with your nearest authorized dealer or service center.

Lamp 1/Lamp2

LED Display		Projector status	Procedure
Off		Lamp is turned off	
Flashing	Green	The lamp is under turning on.	

	Red(1 time in one cycle)	No lamp is in lamp channel	Check and install the lamp in the channel.
	Red (6 time in one cycle)	Light source lit fail	Contact with your nearest authorized dealer or service center.
On	Red	Lamp life exceeds	Contact with your nearest authorized dealer or service center.
	Green	Lamp is turned on	

Shutter LED

LED Display		Projector status	Procedure
Off		Shutter is off	
On	Green	Shutter is enabled.	

Tips for Troubleshooting

In each problem-specific section, try the steps in the order suggested. This may help you to solve the problem more quickly.

- Try to pinpoint the problem to avoid replacing non-defective parts.
- For example, if you replace batteries and the problem remains, put the original batteries back and go to the next step.
- Keep a record of the steps you take when troubleshooting: The information may be useful when calling for technical support or passing on to service personnel.

Image Problems

Problem: No image appears on the screen

1. Verify the settings on your notebook or desktop PC.
2. Turn off all equipment and power up again in the correct order.

Problem: The image is blurred

1. Adjust the Focus on the projector.
2. Performance Auto Sync on the remote control or projector.
3. Ensure the projection distance is within the specified range.
4. Check that if the projection lens is clean.

Problem: The image is wider at the top or bottom (trapezoid effect)

1. Position the projector so it is as perpendicular to the screen as possible.
2. Use the Keystone function to correct the problem.

Problem: The image is reversed or upside down

1. Check the Projection Mode setting on the INSTALLATION->Projection Mode menu.

Problem: The image is streaked

1. Set the Total dots (H Total) and VGA Setup settings on the SIGNAL menu of the OSD to the default settings.
2. To ensure the problem is not caused by a connected PC's video card, connect to another computer.

Problem: The image is flat with no contrast

1. Adjust the Contrast setting on the PICTURE menu of the OSD.
2. Adjust the Brightness setting on the PICTURE menu of the OSD.

Problem: The color of the projected image does not match the source image.

1. Adjust the Color temperature and Gamma settings on the PICTURE menu of the OSD.

Projection Problems

Problem: There is no light from the projector

1. Check that the power cable is securely connected.
2. Ensure the power source is good by testing with another electrical device.
3. Restart the projector in the correct order and check that the Power LED is green.

4. Check if Blank/Shutter function is enabled.

Remote Control Problems

Problem: The projector does not respond to the remote control.

1. Direct the remote control towards remote sensor on the projector.
2. Ensure the path between remote and sensor is not obstructed.
3. Check the battery polarity or replace the batteries.
4. Check the remote sensor on OSD is turned on, you can check the setting via INSTALLATION->Remote Sensor. The remote sensor is turned off if it's set to HDBaseT or Off.
5. Ensure remote control wire is not plugged in the projector.
6. Turn off any fluorescent lights in the room.
7. Turn off other Infrared-enabled devices in the vicinity.
8. Have the remote control serviced.
9. Ensure that the remote control code conforms to the projector's code if universal remote control is used.

Projection Lens Problems

Problem: The Zoom or Focus adjustment can't work.

1. Check if the lens is installed properly, improper lens installation may cause to lens can't work normally. Please follow the lens installation procedure to check again.
2. Perform Center Lens function to calibrate the Lens again.
3. Make sure Lens Lock function is not enabled.
4. Replace the other lens to check the problem if the lens is available.
5. Contact with service center for the details.

Remote communication Problems

Problem: The projector does not respond to Ethernet control

1. Make sure Standby model is set to Network Standby; the communication path is interrupted if it's set to Eco (less 0.5W).
2. Check the network configuration in your laptop and projector; refer to Remote Communication manual for more information.

About the Vivitek Support

If you cannot find solutions from this user guideline, please contact us using the contact information below:

North America

Vivitek Service Center
15700 Don Julian Road, Suite B
City of Industry, CA. 91745
U.S.A
Tel: 855-885-2378 (Toll-Free)
Email: T.services1@vivitekcorp.com
URL: www.vivitekusa.com

Europe and Africa

Vivitek Service & Support
Zandsteen 15
2132 MZ Hoofddorp
The Netherlands
Tel: +31 20 655 0960
Email: support@vivitek.eu
URL: www.vivitek.eu

China

Vivitek Service Center
201209, Room 1802, 18/F, Cimic Tower, No.1090, Century Avenue, Pudong, Shanghai
Tel: 400-888-3526 (Toll-Free)
Tel: 021-58360088-142 (Direct)
Email: service@vivitek.com.cn
URL: www.vivitek.com.cn

Asia and Taiwan

VIVITEK after-sales service
Vivitek Corporation, Co., Ltd.
4F., No.186, Ruiguang Rd., Neihu Dist., Taipei City 11491
TEL: 86-28-797-2088
FAX: 86-26-600-2358
E-mail: kenny.chang@vivitek.com.tw
URL: www.vivitek.com.tw